

SANDY WALL

Assembly and Installation Instructions

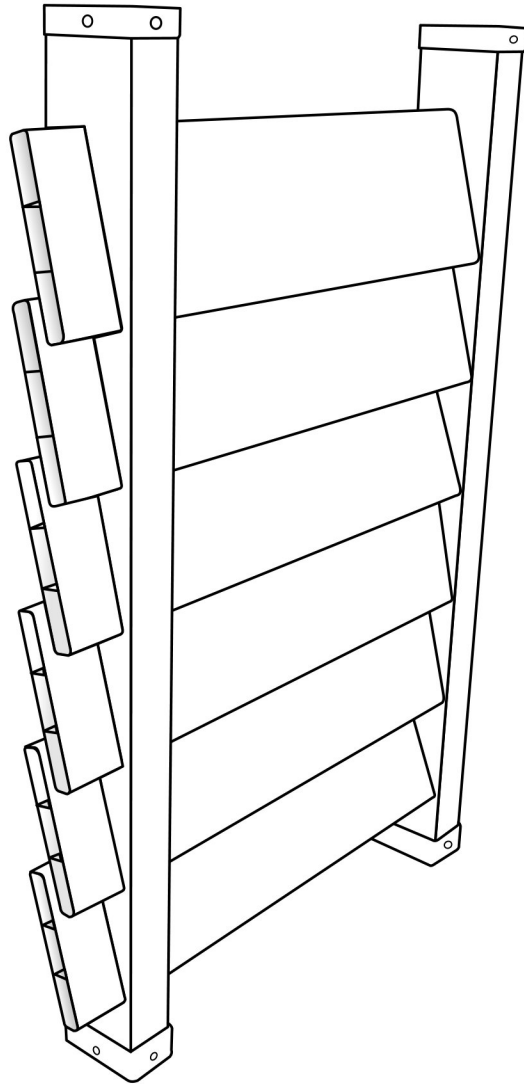

PLEASE READ INSTALLATION INSTRUCTIONS
COMPLETELY BEFORE STARTING.

Installation Support Hotline 1-800-499-FENCE

Thank you for purchasing Sandy Wall.

Please read installation instructions completely before beginning assembly.

IMPORTANT:

Before you begin...

- Check Local Zoning Laws.

Zoning laws may restrict the location and height of your installation, permits may also be required.

- Underground Utilities.

Dial 811 and pay to have underground utility lines marked. Even at shallow depths utility lines can be present.

- Check that all tools and materials are present to properly assemble your Louvered Piling.

Sandy Wall Parts and Assembly

PLEASE TAKE A COMPLETE INVENTORY OF ALL PARTS PRIOR TO Beginning ASSEMBLY. DO NOT ATTEMPT TO ASSEMBLE IF PARTS ARE MISSING OR DAMAGED.

For replacement parts or assistance dial:

1-800-499-FENCE

Vinyl Louvers

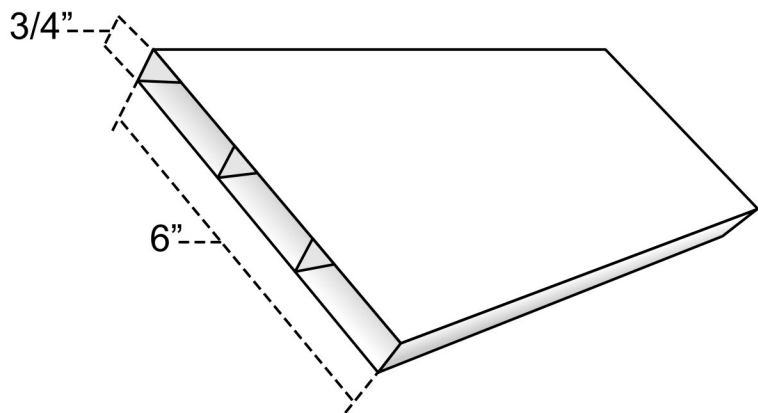

Vertical Supports

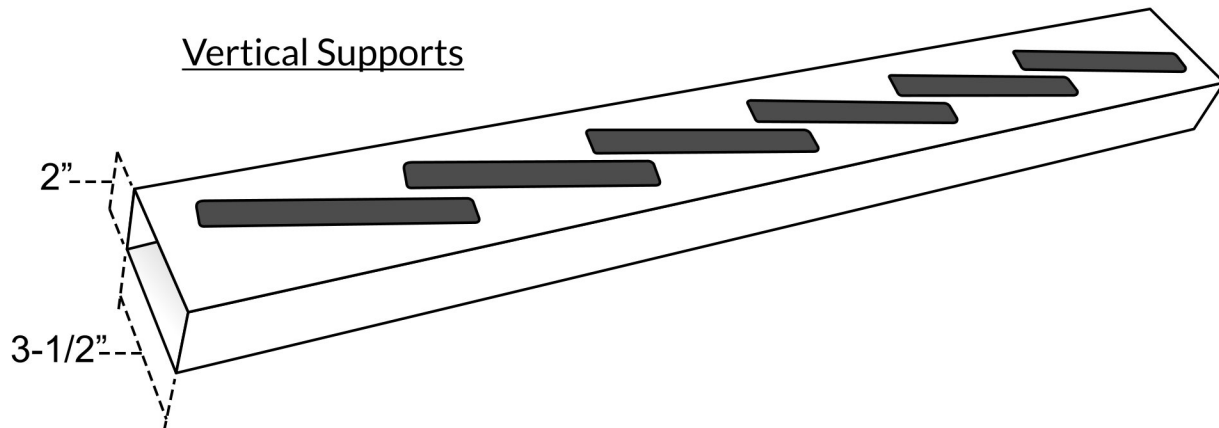

1-800-499-FENCE

Installation Support Hotline /
www.DennisvilleFence.com



Assembly Instructions

1. Measure End to End and Deduct 1/2" From Opening.



Measure End to End and Deduct 1/2" From Opening

Optional: If Installing Sandy Wall On Top Of Dirt, Dig Holes To Place The Supports Into.

2. Cut Horizontal Louvers to Necessary Length.

3. Drill 5/8" Hole On Inside Of Left End Support and Right End Support.

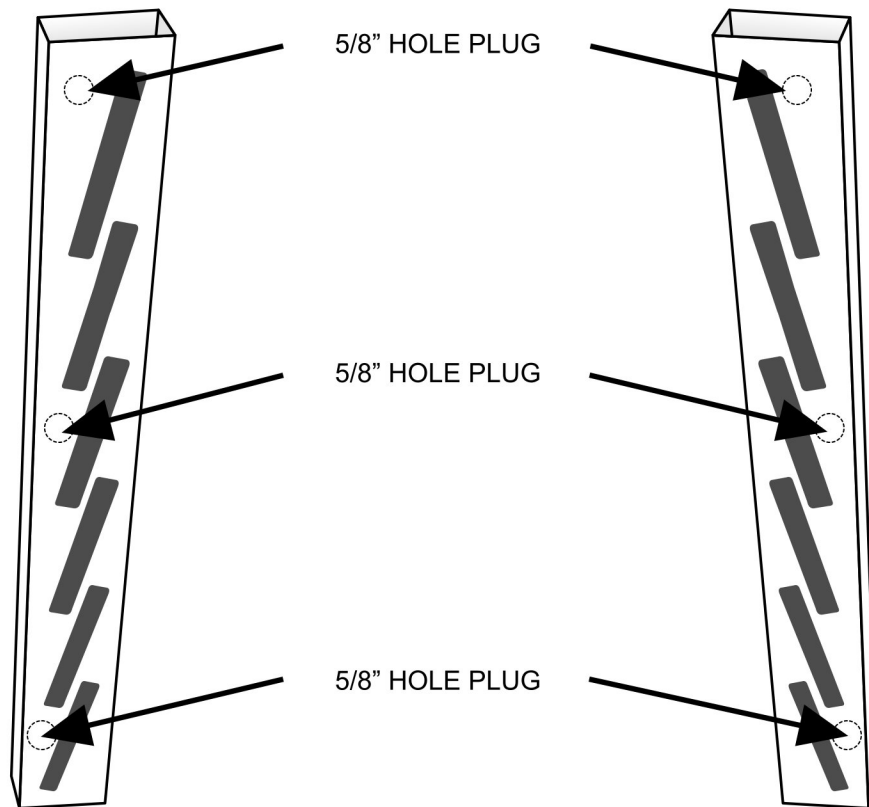

4. Assemble Sandy Wall Using Left End Support, In-Line Support If Needed* and Right End Support.

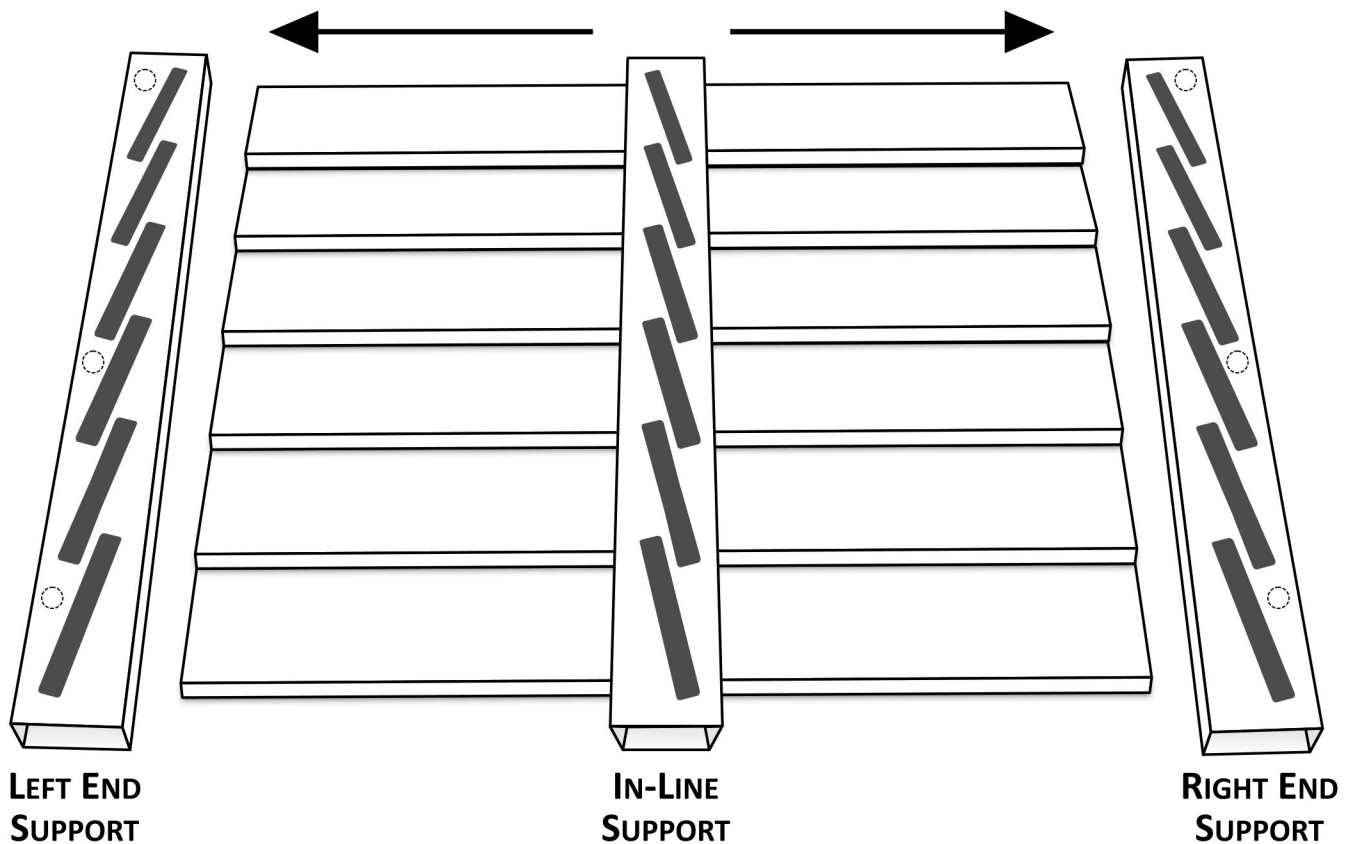

***Note: Spans Over 6Ft Require Placement Of An In-Line Support.
In-Line Supports Must Be Spaced At Least Every 6ft
For Optimal Structural Integrity.**

5. Insert Screws In Drilled Holes To Attach and Secure Sandy Wall Support To Existing Piling/Column. Place 5/8" Hole Plugs Into Hole.

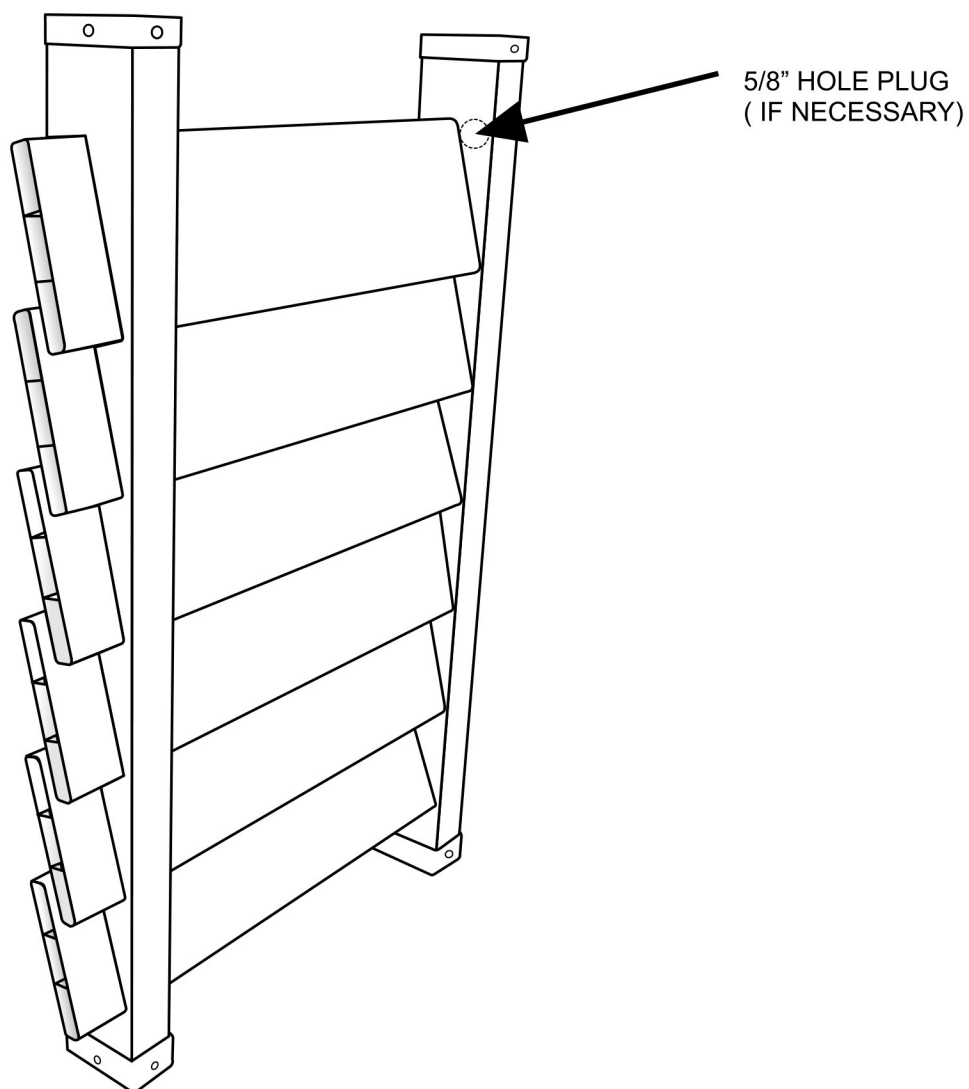

Optional: Secure Top Of Sandy Wall To Structure Using Rail Mount Brackets.

Installation Example

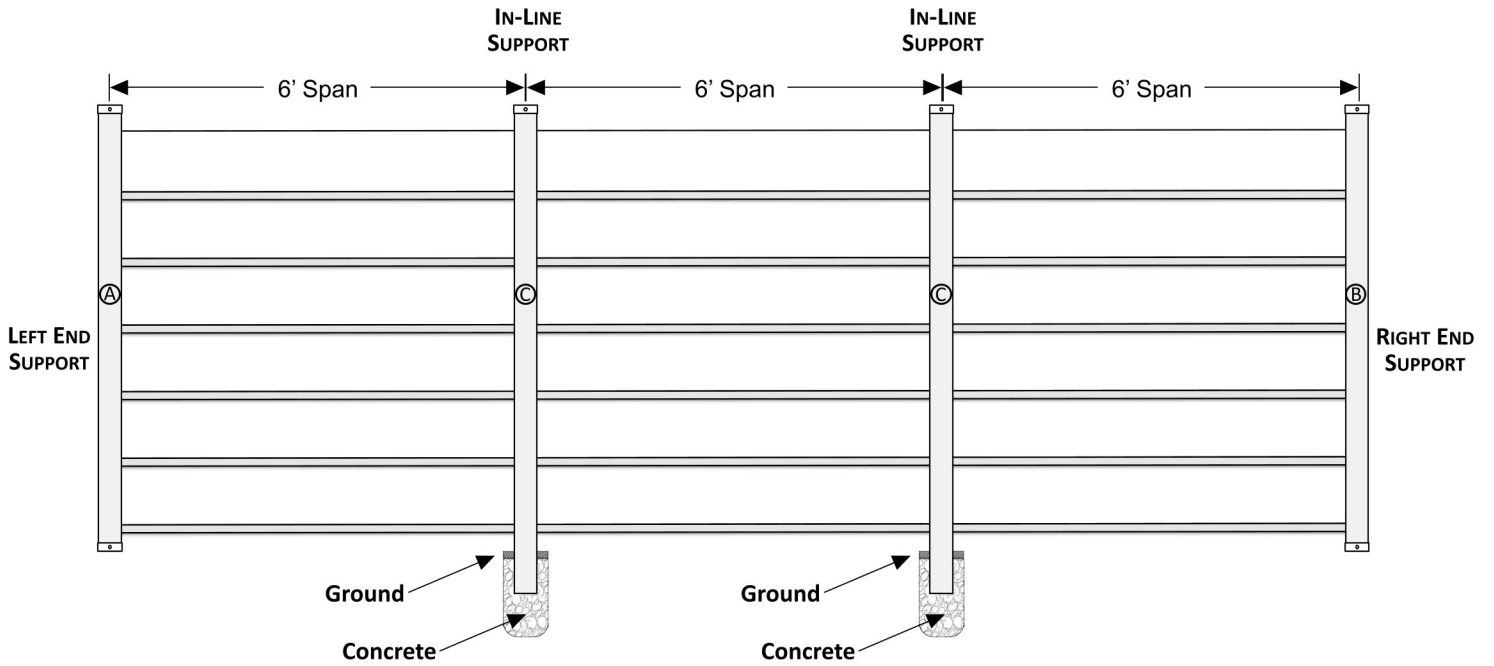

- Ⓐ Left End Support
- Ⓑ Right End Support
- Ⓒ In-Line Support

