

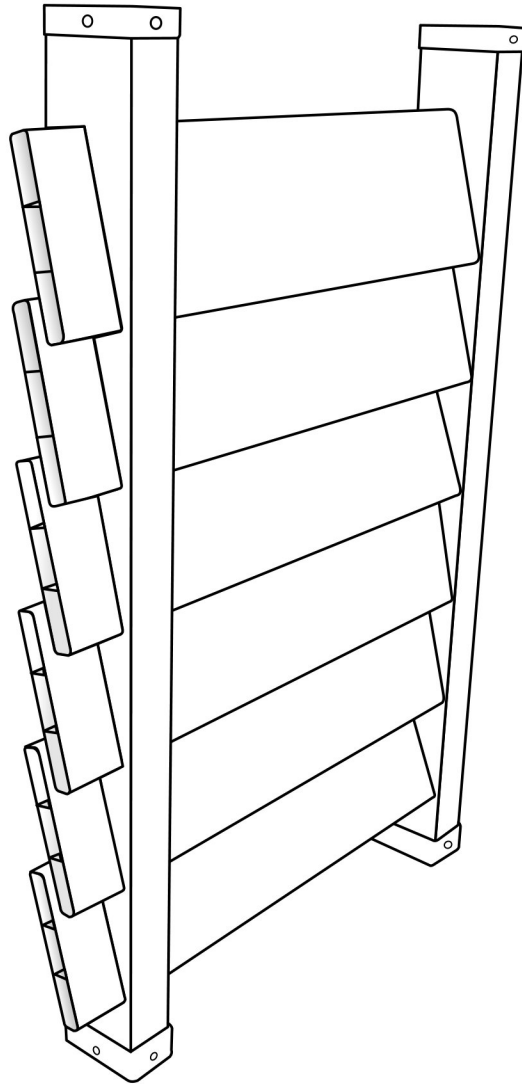

# ***LOUVERED PILING***

## *Assembly and Installation Instructions*



PLEASE READ INSTALLATION INSTRUCTIONS COMPLETELY BEFORE STARTING.

*Installation Support Hotline 1-800-499-FENCE*

# LOUVERED PILING

1-800-499-FENCE

Installation Support Hotline /  
[www.DennisvilleFence.com](http://www.DennisvilleFence.com)

Thank you for purchasing Louvered Piling.

Please read installation instructions completely before beginning assembly.

## IMPORTANT:

Before you begin...

- Check Local Zoning Laws.

Zoning laws may restrict the location and height of your installation, permits may also be required.

- Underground Utilities.

Dial 811 and pay to have underground utility lines marked. Even at shallow depths utility lines can be present.

- Check that all tools and materials are present to properly assemble your Louvered Piling.

## Louvered Piling Parts and Assembly

PLEASE TAKE A COMPLETE INVENTORY OF ALL PARTS PRIOR TO Beginning ASSEMBLY. DO NOT ATTEMPT TO ASSEMBLE IF PARTS ARE MISSING OR DAMAGED.

For replacement parts or assistance dial:

**1-800-499-FENCE**

Vinyl Louvers

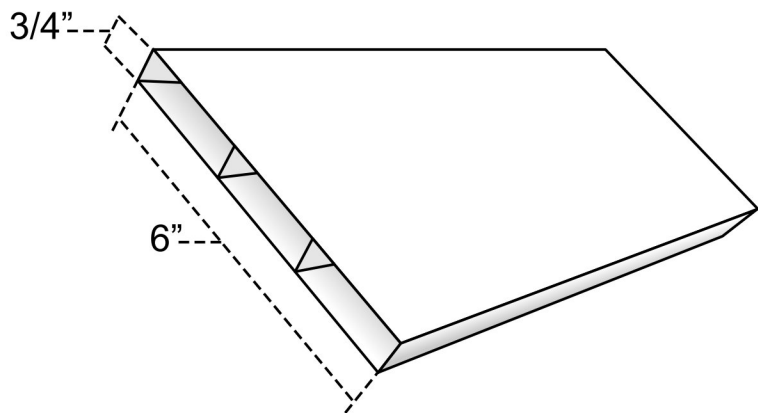

Vertical Supports

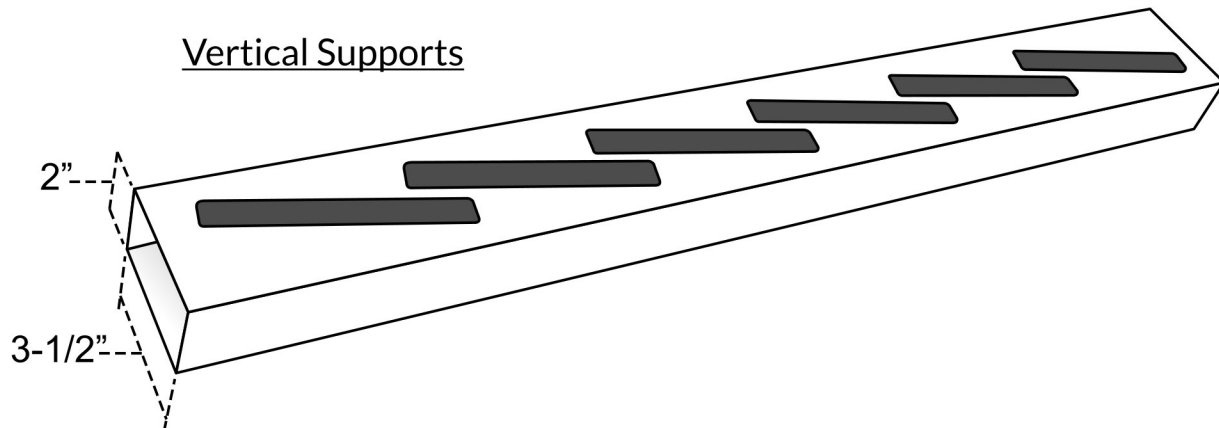

## Assembly Instructions

### 1. Measure End to End and Deduct 1/2" From Opening.



Measure End to End and Deduct 1/2" From Opening

**Optional:** *If Installing Louvered Piling On Top Of Dirt,  
Dig Holes To Place The Supports Into.*

### 2. Cut Horizontal Louvers to Necessary Length.

# LOUVERED PILING

1-800-499-FENCE

Installation Support Hotline /  
[www.DennisvilleFence.com](http://www.DennisvilleFence.com)

## 3. Drill 5/8" Hole On Inside Of Left End Support and Right End Support.

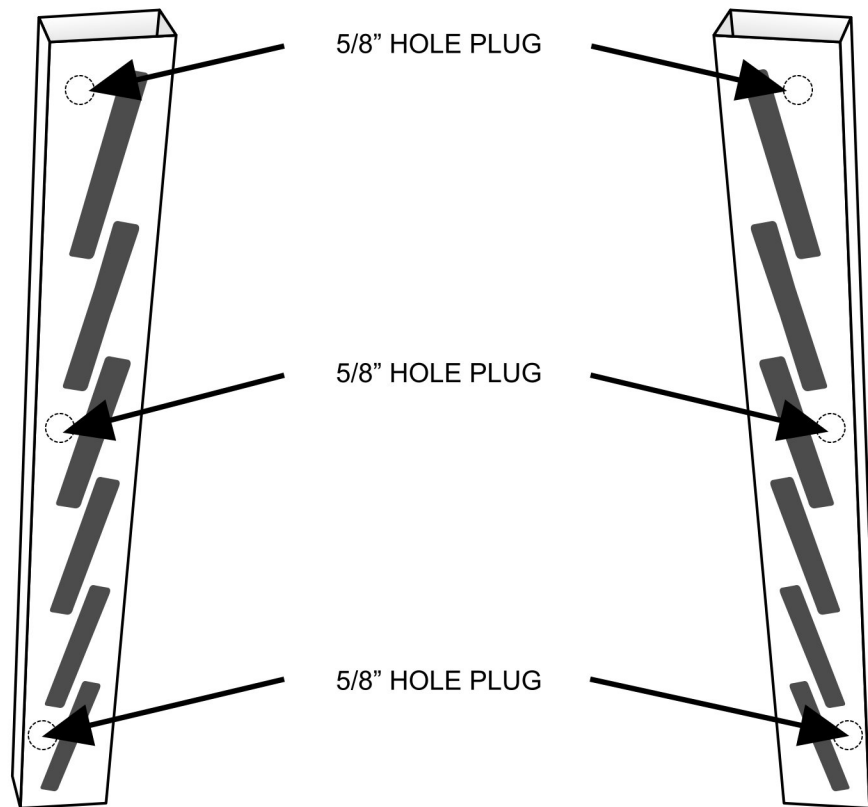

## **4. Assemble Louvered Wall Using Left End Support, In-Line Support If Needed\* and Right End Support.**

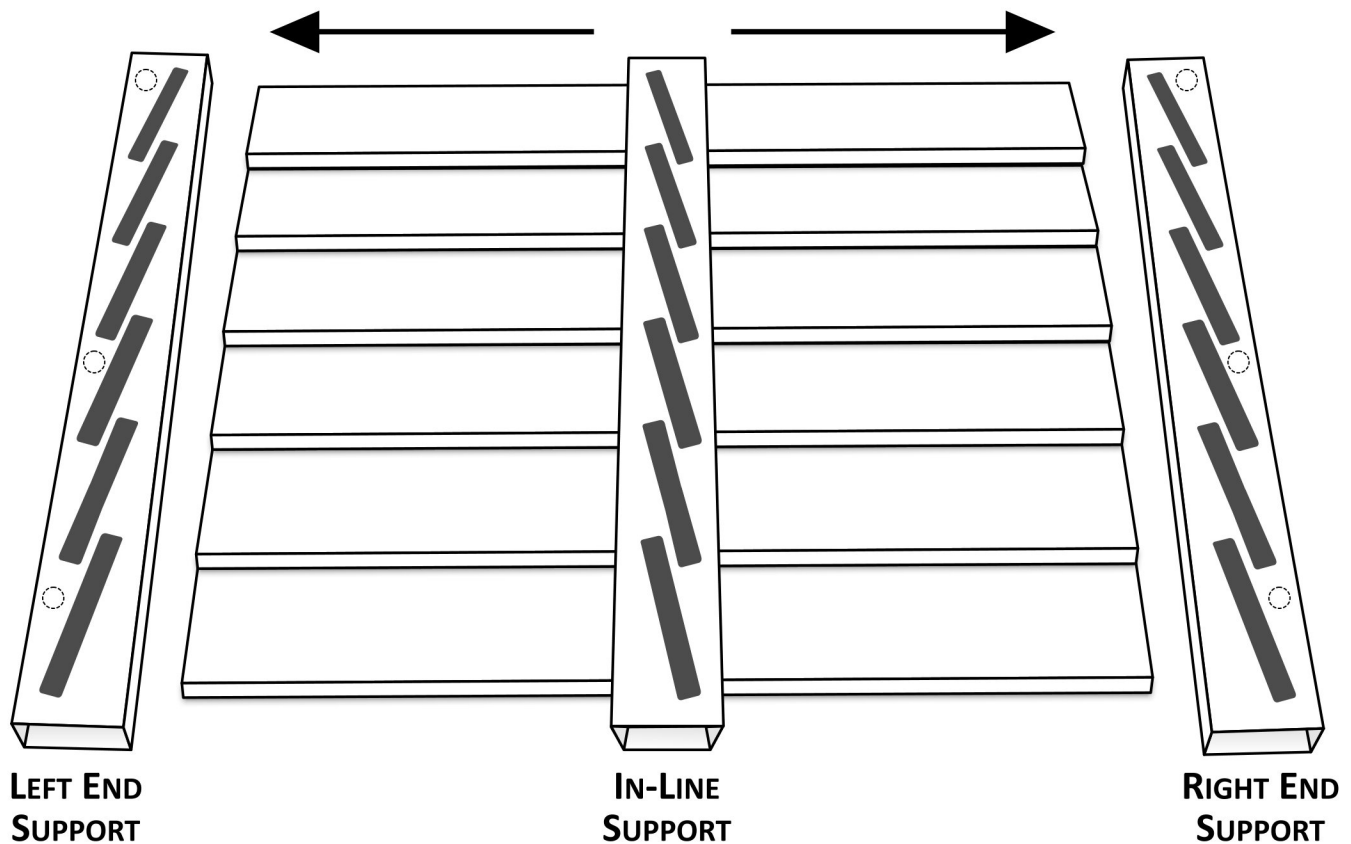

**\*Note: Spans Over 6Ft Require Placement Of An In-Line Support.  
In-Line Supports Must Be Spaced At Least Every 6ft  
For Optimal Structural Integrity.**

# LOUVERED PILING

1-800-499-FENCE

Installation Support Hotline /  
[www.DennisvilleFence.com](http://www.DennisvilleFence.com)

**5. Insert Screws In Drilled Holes To Attach and Secure Louvered Piling Support To Existing Piling/Column. Place 5/8" Hole Plugs Into Hole.**

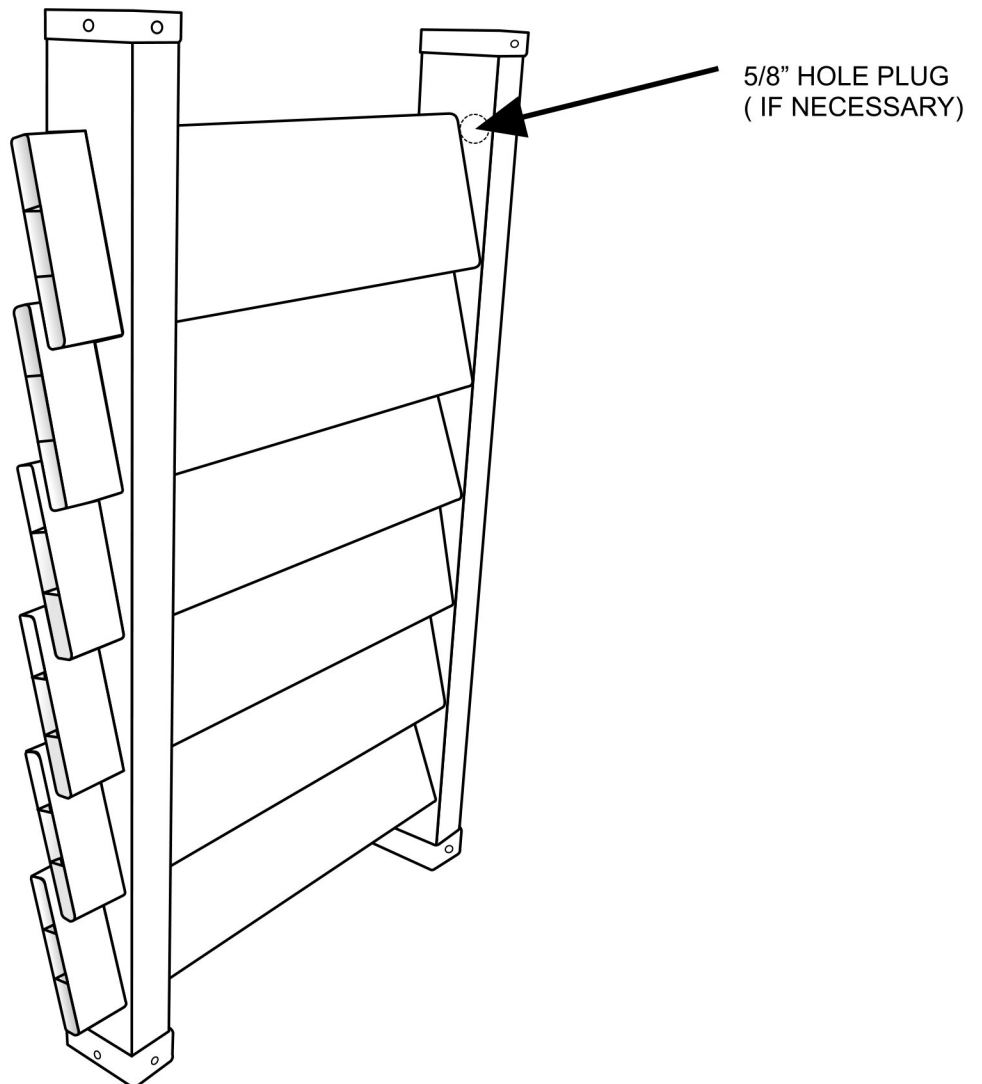

**Optional: Secure Top Of Louvered Piling To Structure Using Rail Mount Brackets.**

## Installation Example

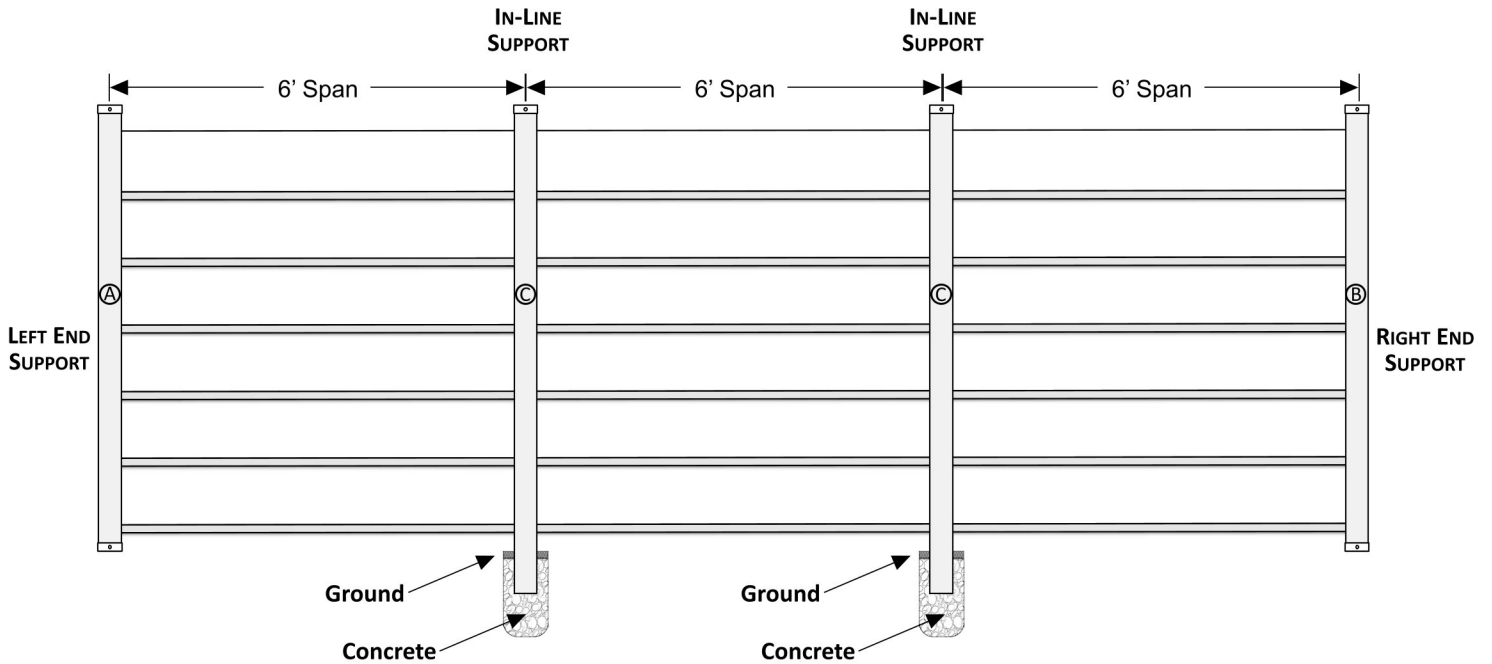

- Ⓐ Left End Support
- Ⓑ Right End Support
- Ⓒ In-Line Support

