

**Liquid Sunshine<sup>®</sup>**  
**OUTDOOR PRODUCTS**

## **VINYL SHOWER ENCLOSURE KIT**

**Assembly and Installation Instructions**

**200 Series**  
**4x6**

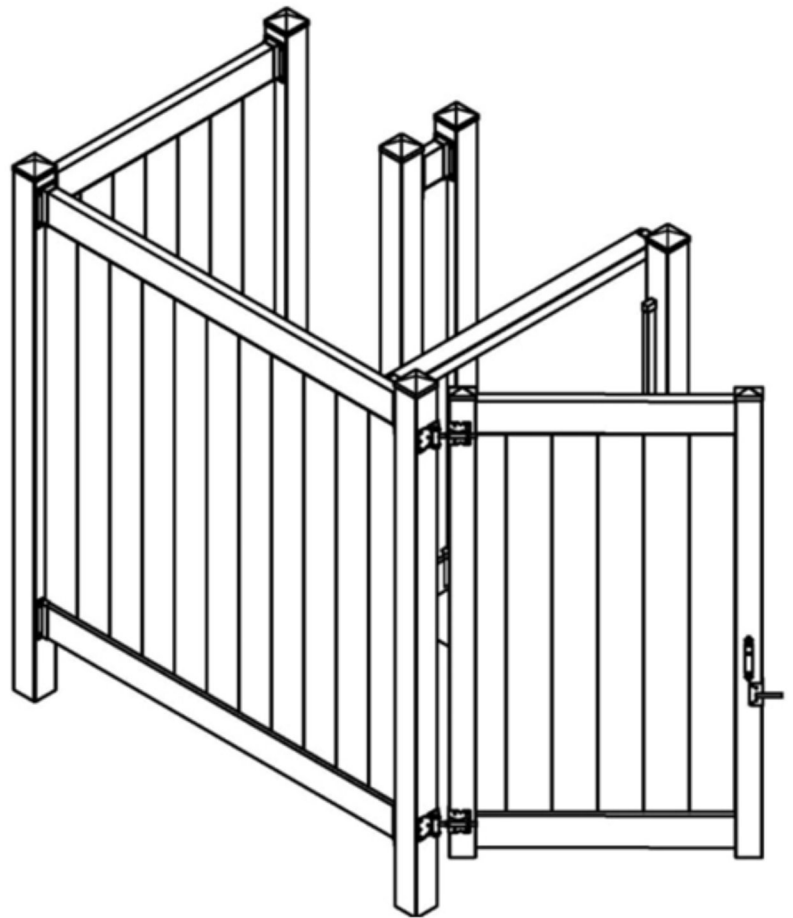

*Read Installation Instructions Completely Before Starting.*

**INSTALLATION SUPPORT HOTLINE:**

**CALL 1-844-743-5140**

*View Installation Videos At:*

**WWW.OUTSIDESHOWER.COM**

Thank you for purchasing the Liquid Sunshine Outdoor Vinyl Shower Enclosure Kit.  
Please read installation instructions completely before assembling your enclosure.

## 200 Series (4 x 6)

Consider the following Layout Options:

**Note:** Partition Walls are available for this Series Enclosure.

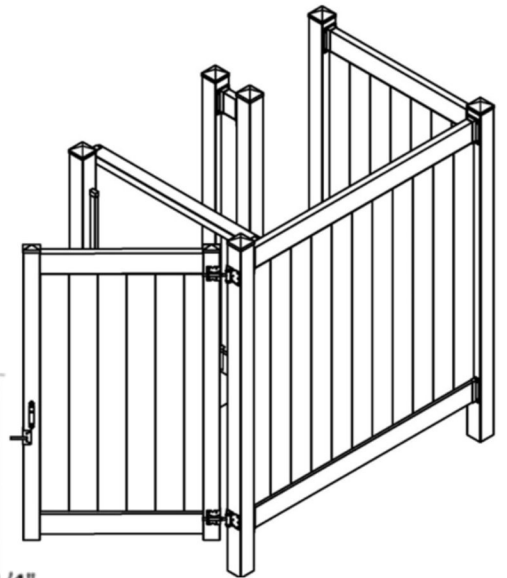
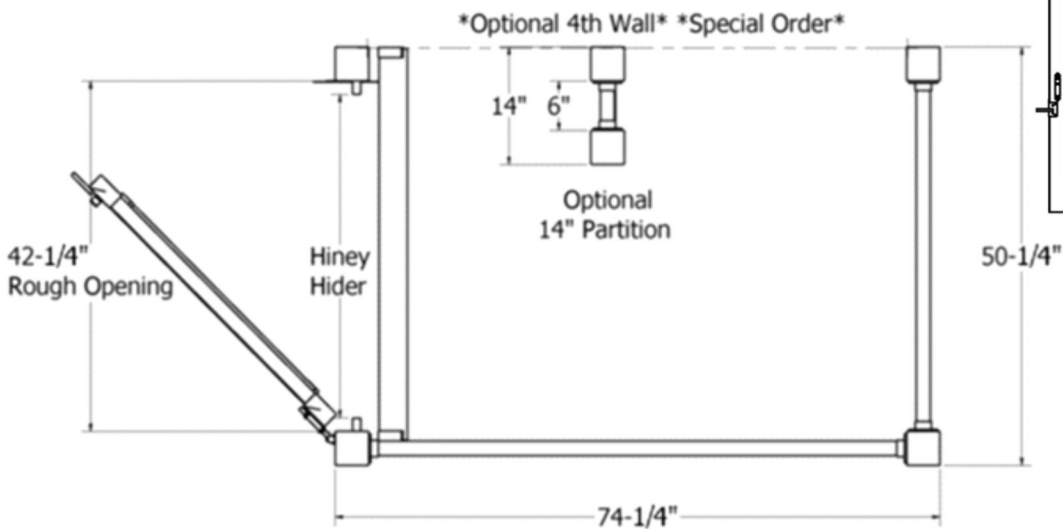
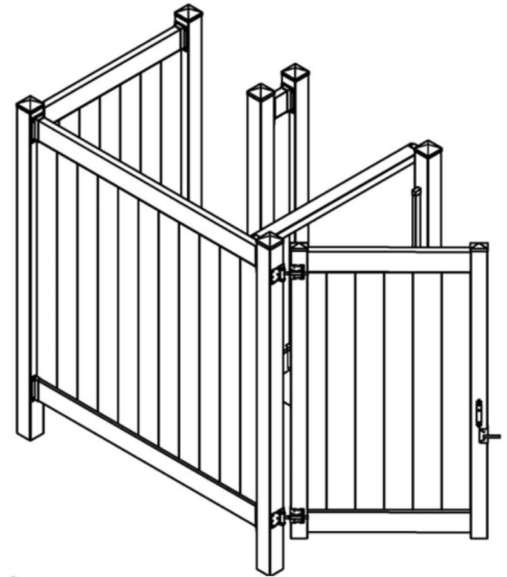
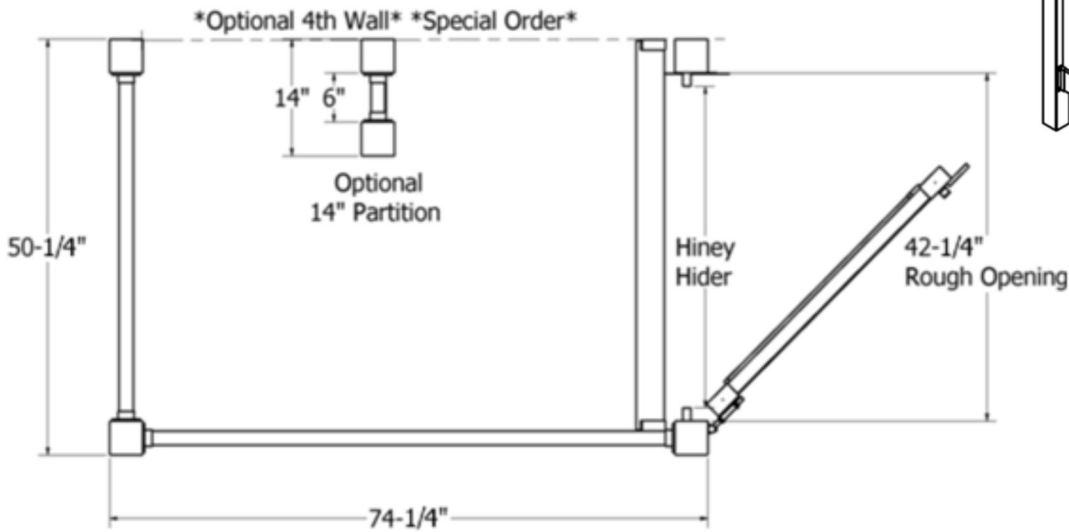

**\*\*Note:** 4th walls are still available for layout designs with doors adjacent to the wall of the house\*\*

## **IMPORTANT:**

*Before you begin...*

- *Check Local Zoning Laws.*

*Zoning laws may restrict the location and height of your enclosure, permits may also be required.*

- *Underground Utilities.*

*Dial 811 and pay to have underground utility lines marked. Even at shallow depths utility lines can be present.*

- *Check that all tools and materials are present to properly assemble your enclosure.*

## **Models with Louvered Roofs:**

**Vinyl posts must be cut to 90” instead of 84” to accommodate for Louvered Roof assembly.**  
**(See page 6)**

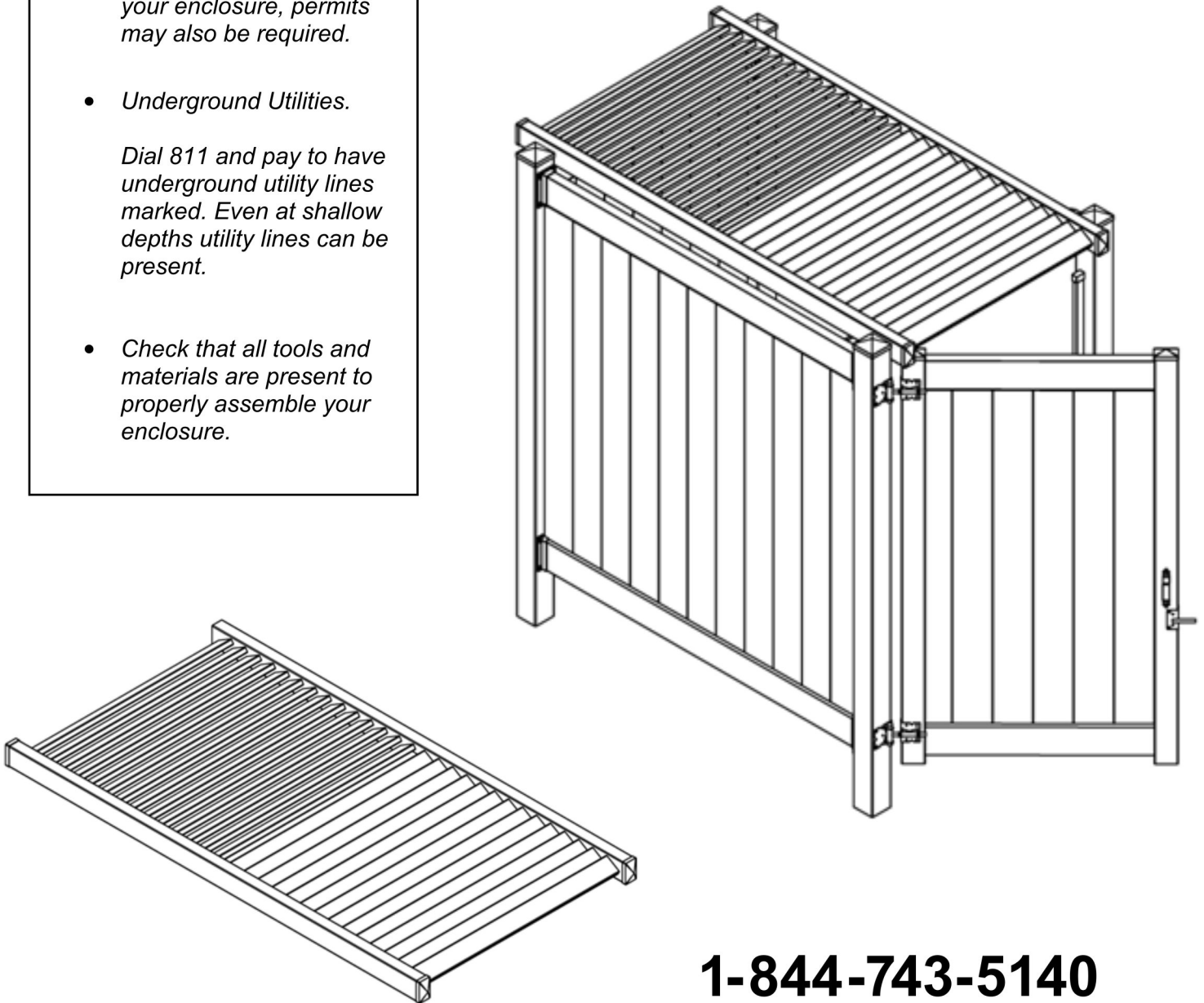

*Louvered Roof Available with Special Order.*

**1-844-743-5140**

*Installation Support Hotline*

*WWW.OUTSIDESHOWER.COM*

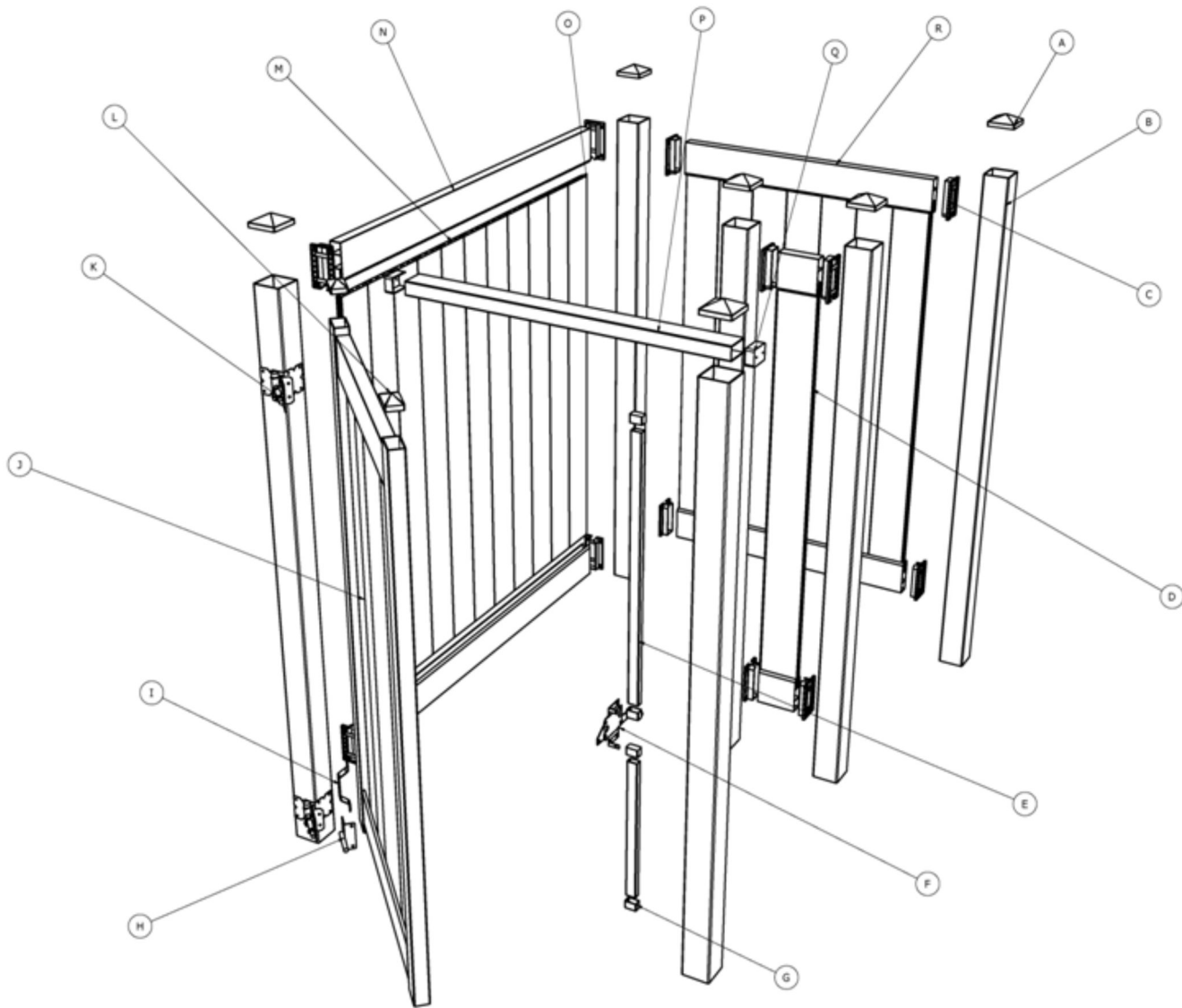

**PART LEGEND**

		Qty			Qty
A	4" Flat Cap	4	J	Door (Un-Assembled)	1
B	4" x 4" Post 96" long, each	4	K	Self-Closing Hinge	2
C	Bracket Kit (2 per pack)	4	L	2" x 3-1/2" Door Cap	2
D	Partition Wall (Optional)	1	M	Tongue and Groove Boards	18
E	Privacy Strip 84" (Field Cut)	2	N	Deco Rail (Lengths Vary)	4
F	Paddle Latch	1	O	U-Channel Strip 61" long	4
G	Privacy Strip End Cap	6	P	2" x 3-1/2" Rail Transom	1
H	Door Bolt (w/Paddle Latch)	1	Q	2" x 3-1/2" Rail Mount	2
I	Gate Handle	1	R	Wall Panel (Un-Assembled)	2

*\*\*When necessary materials may be cut or modified to fit application parameters\*\**

# Enclosure Parts and Assembly

PLEASE TAKE A COMPLETE INVENTORY OF ALL PARTS PRIOR TO ENCLOSURE ASSEMBLY. DO NOT ATTEMPT TO ASSEMBLE IF PARTS ARE MISSING OR DAMAGED.

For replacement parts or assistance dial:

**1-844-743-5140**

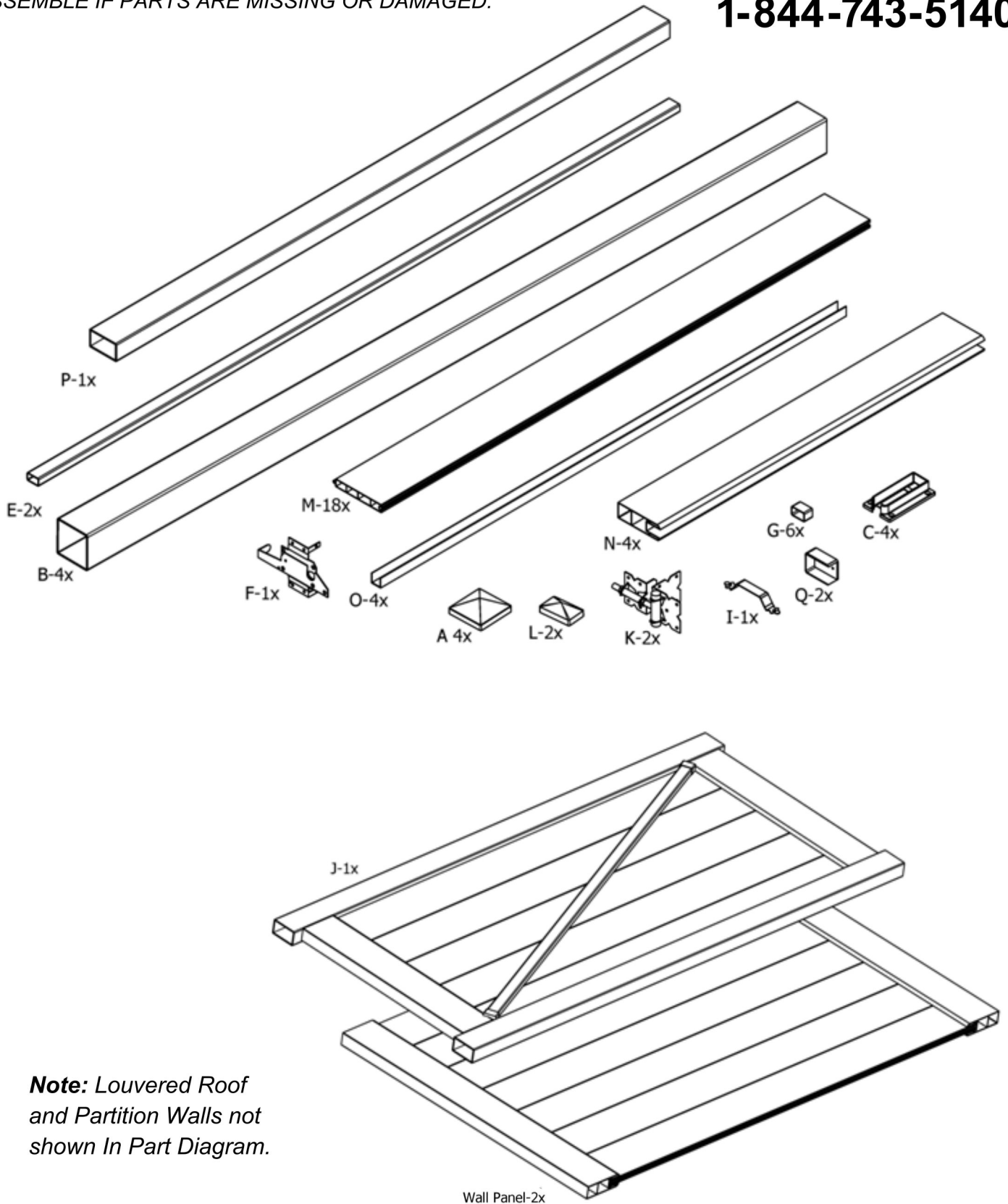

**Note:** Louvered Roof and Partition Walls not shown In Part Diagram.

## Assembly Instructions

### Tool List:

- Circular Saw / Hand Saw / Chop Saw
- Line Level
- Post Level
- Tape Measure
- Ratchet Set
- Drill Gun #2, #3 Phillips
- Driver Bit Extender (Recommended)
- Hammer
- Mallet
- Rags and Spray Cleaner
- Safety Glasses
- Black Sharpie or Carpenters Pencil

### Additional Tools Required for:

#### GROUND FOOTING INSTALLATION:

- Post Hole Digger (Auger Recommended)
- Shovel
- Pre-Mix Concrete (6 Bags)
- 4x4 by 96 Lumber (4x)

#### CONCRETE / WOOD DECK MOUNT INSTALLATION:

##### Concrete:

- Hammer Drill
- Masonry Drill Bit
- Impact Gun / Ratchet Set
- Cement Fasteners (4 / Post)

##### Wood Deck:

- Wood Drill Bit
- Wood Fasteners (4 / Post)

## 1. Measure and Mark Post Layout

Measure, mark, and “square” posts according to dimensions shown. Use “Corner to Corner Diagonal” dimension as a reference to ensure that posts are squared.

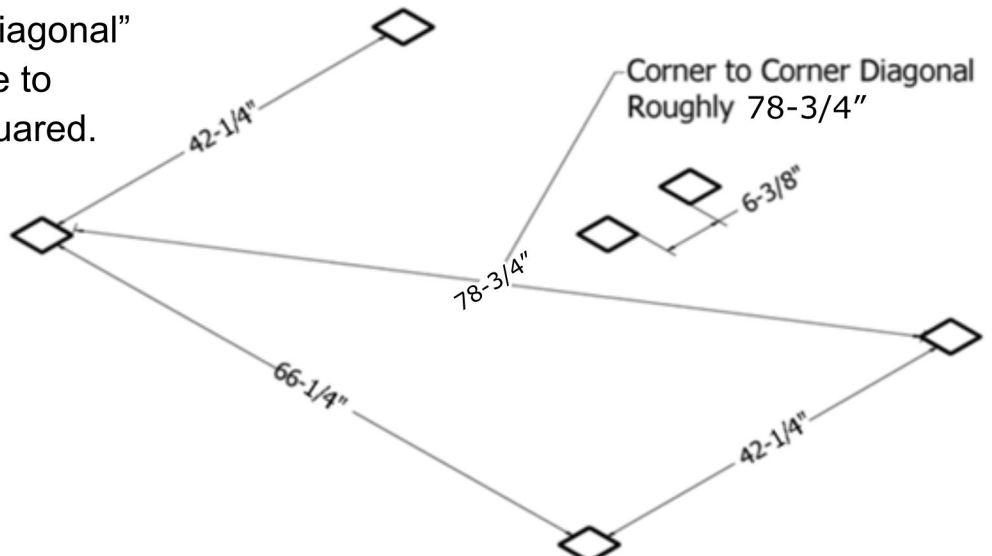

## 2. Post Installation

### ***In-Ground Method:***

1. Dig a 3' deep by 10" diameter hole for each post footing. Use a **Post Hole Digger** when an **Auger** is not available.
2. Slide vinyl posts over **4x4 by 96" lumber** so that 2 feet of lumber is extended below vinyl posts. Secure lumber to posts with **screws** below finish grade.
3. Insert posts and double-check measurements. Pour **pre-mixed concrete** into holes and use a **post level** to make plumb.

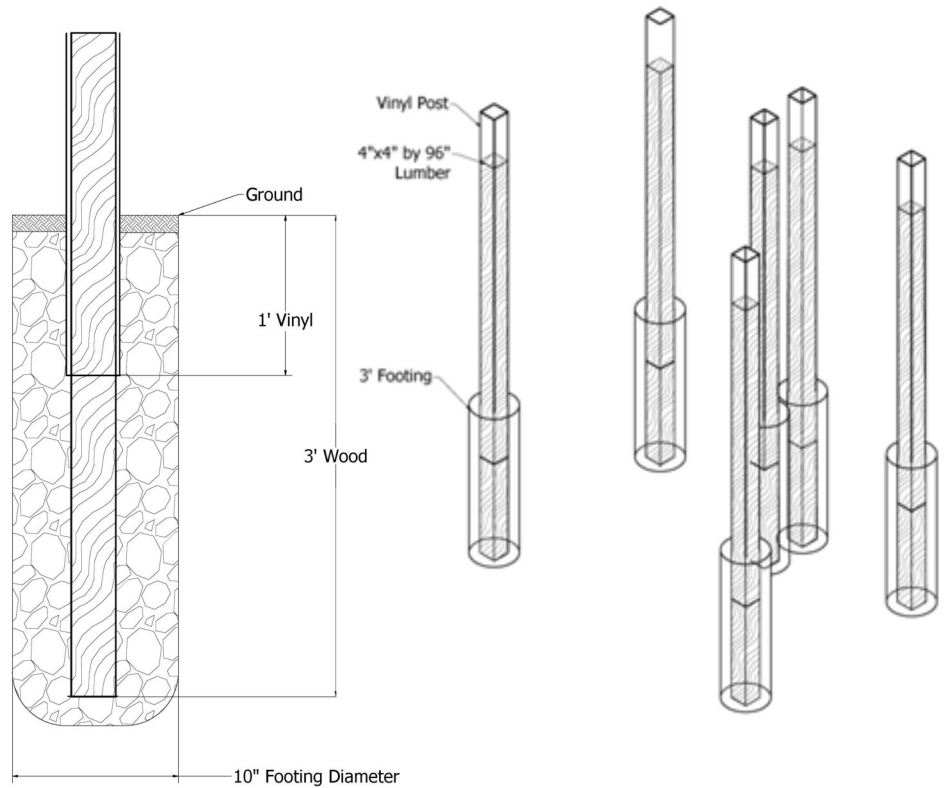

### ***IMPORTANT:***

***For Louvered Roofs, allow vinyl posts to stand 90" above ground (6" in footing) and 80" for partition posts.***

### ***Post Mount Method:***

1. Pre-drill four holes per mount using appropriate **drill** and **bit** sizes for your fastener.
2. Secure with **cement screw anchors** for concrete, or **lag bolts** for wood surfaces.
3. Cut vinyl posts to desired height with **saw**. Recommended post height is 84", or 90" with Louvered Roof.
4. Slide vinyl posts over mounts. Vinyl posts can be secured to mounts with **screws** but is not required.

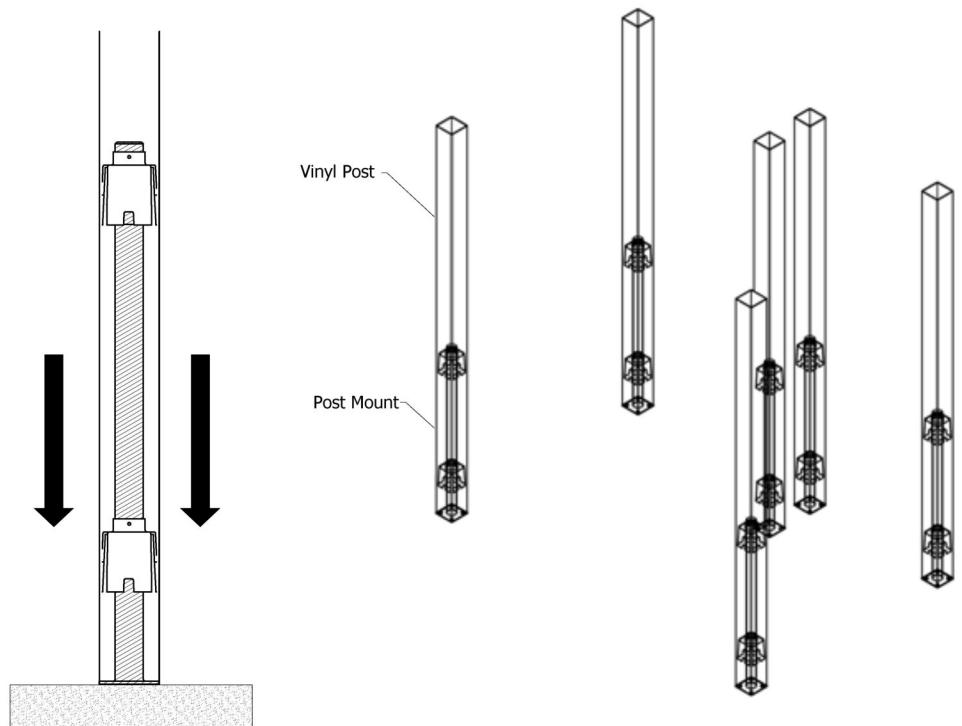

# 3. Wall Panel Installation

## Step-1 Bottom Rail

1. Slide brackets onto bottom rail and lift into place between posts.
2. Offset bottom brackets 10" above finish grade and center bottom rail on posts.
3. Mount brackets to posts using **4 screws** per bracket. Insert white caps to hide screws.

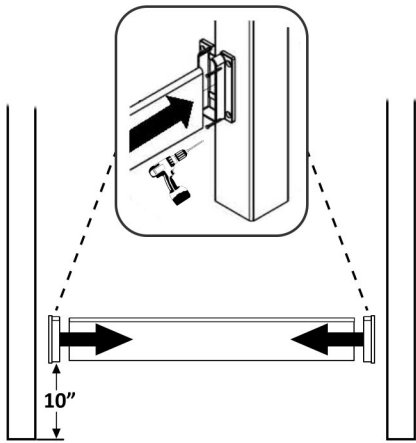

## Step-2 Vertical T&G Boards

1. Place U-Channels vertically on edges of T&G Boards #1 and #7 (42-1/4" Wall), #1 and #11 (66-1/4" Wall) as shown.
2. Insert vertical T&G boards into bottom rail from left to right.

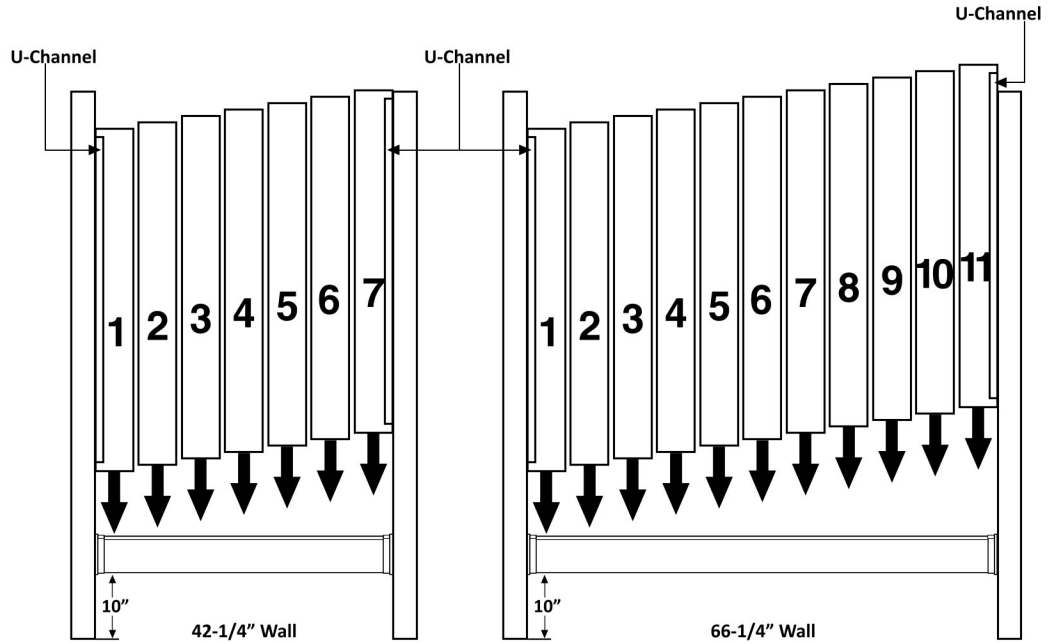

## Step-3 Top Rail

1. Slide brackets onto top rail and place on top of vertical T&G boards.
2. Mount brackets to posts using **4 screws** per bracket. Insert white caps to hide screws.

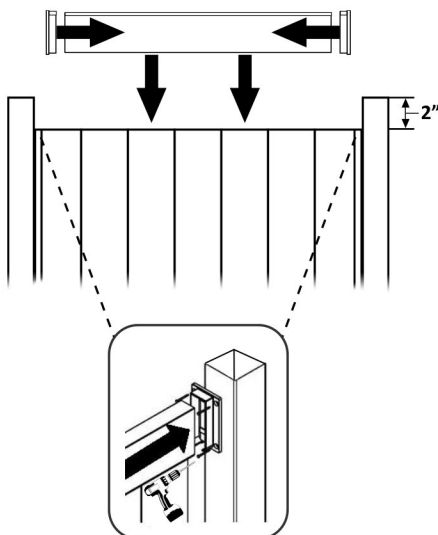

# 4. Rail Transom Installation

1. Install rail mounts on the interior side of top deco rails near door location. Rail mounts should be flush with deco rails and rest against wall brackets.
2. **Measure** and **cut** rail transom to fit snugly between rail mounts.
3. Slide rail transom into place and secure with **screws**.

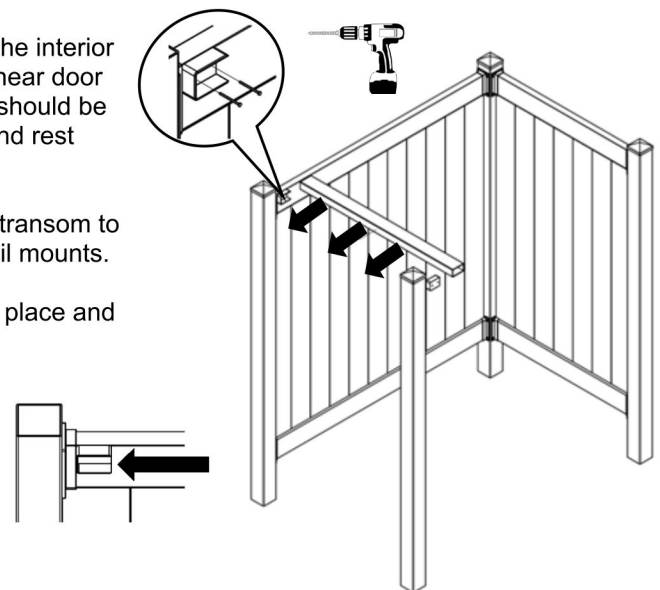

**Alternate:** If assembly follows layout options 2 or 3, screw rail mount to wall of house and measure and cut rail transom accordingly.



# 5. Door Assembly

## PART LEGEND

Qty

A	Door Upright	2
B	Deco Rail	2
C	Tongue and Groove Boards	5
D	Ripped Tongue and Groove Board	1
E	U-Channel Strip	2
F	Brace	1
G	Brace End Cap	2
H	Door Upright End Cap	2
I	Screws	15

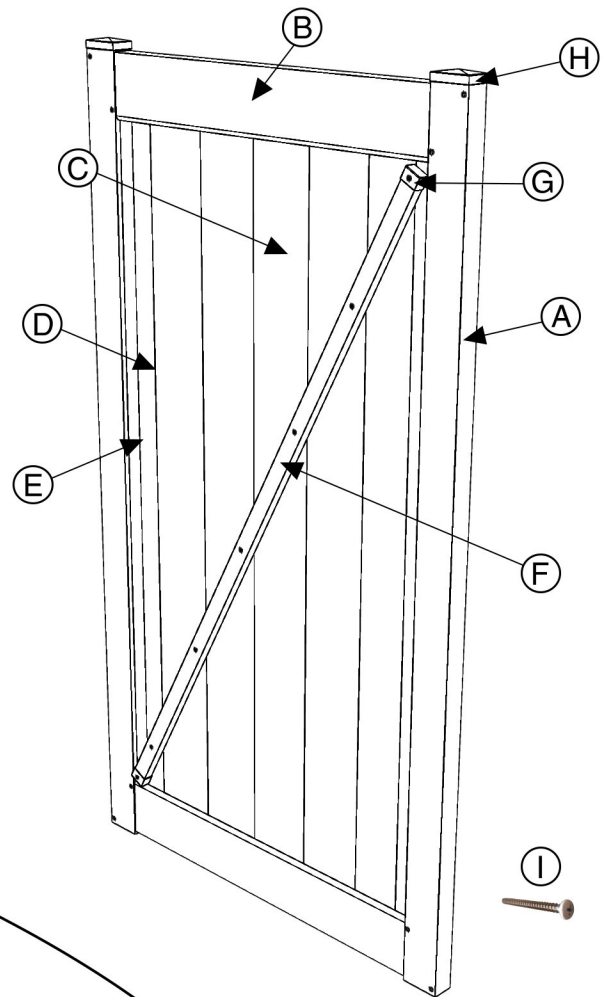

1. Insert Deco Rails (B) into Door Upright (A).
2. Insert Tongue and Groove Board (C) with U-Channel Strip (E) into Deco Rails (B) and Slide down until the U-Channel Strip (E) is flush against the Door Upright (A).

**Note:** The Tongue and Groove Boards must be oriented so that the Tongue is up and the Groove is down.

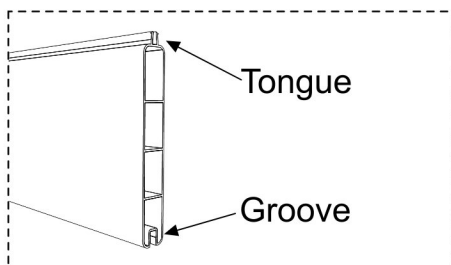

**Note:** The U-Channel Strip should be centered with the Tongue and Groove Board. Separate the U-Channel Strip from the Tongue and Groove Board and reposition if needed.

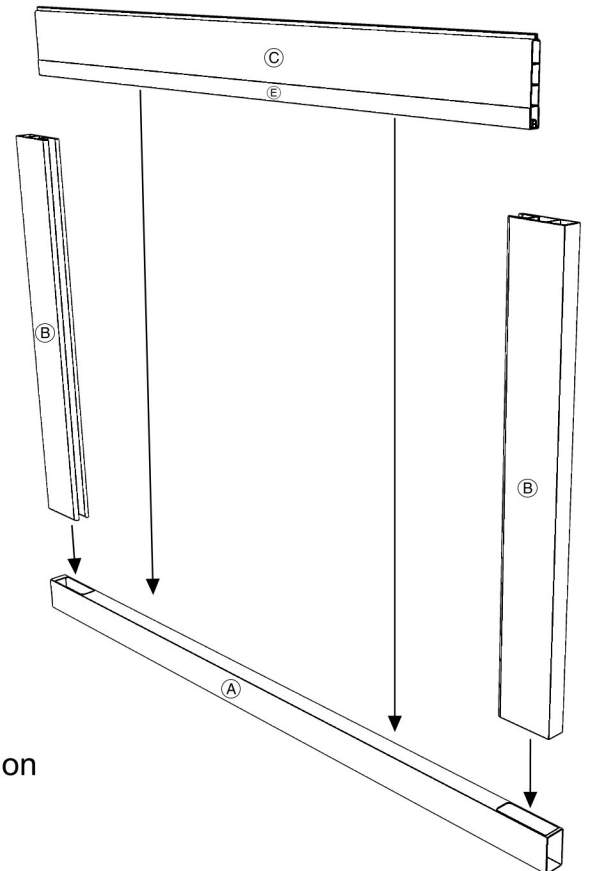

## 5. Door Assembly (Continued)

- Slide remaining Tongue and Groove Boards (C) into Deco Rails (B) pushing each "Groove" onto the "Tongue" of the Board below it until they snap together.

The Ripped Tongue and Groove Board (D) with U-Channel Strip (E) should be placed last.

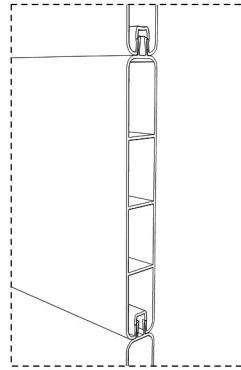

"Tongue" and "Groove" snap and lock together.

- Note:** The U-Channel Strip should be centered with the Ripped Tongue and Groove Board.

If needed, Separate the U-Channel Strip from the Ripped Tongue and Groove Board and reposition.

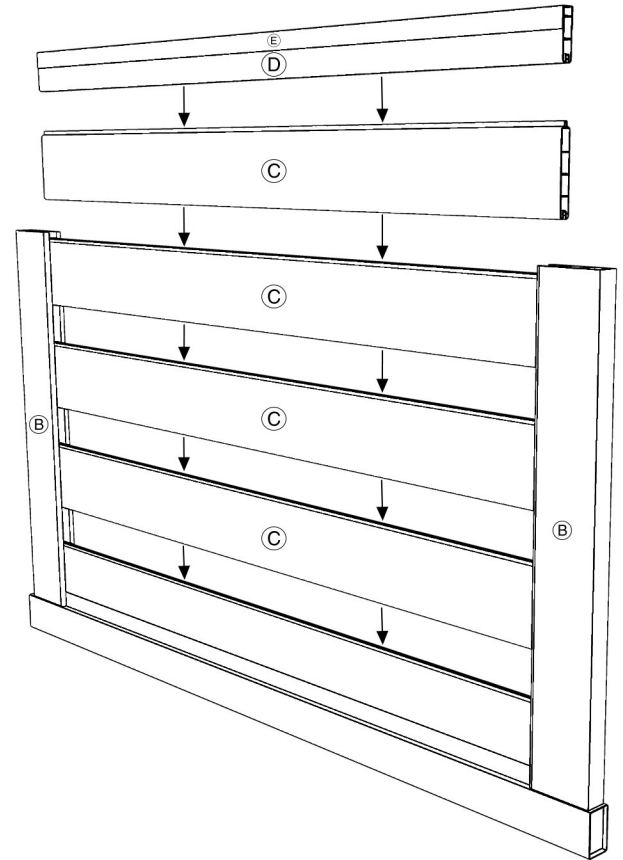

- Place Door Upright (A) onto Ends of Deco Rails (B).

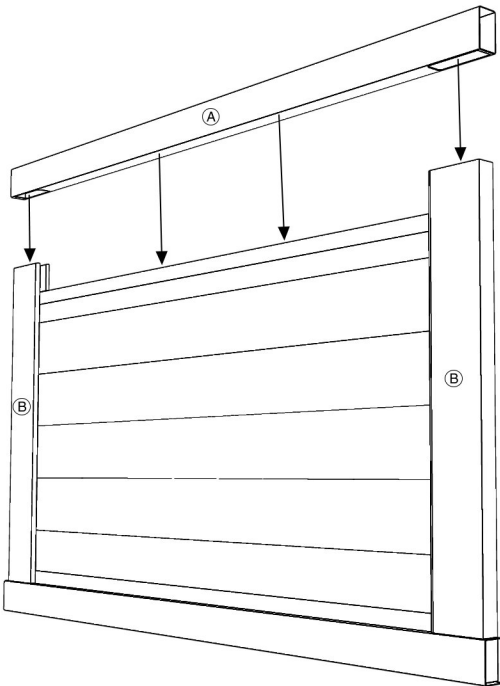

- Place Door on a Flat Surface with the side of the door that will be the "back" facing up to Square the Door.

Measure diagonally from top of Left Door Upright to bottom of Right Door Upright.

Then, measure diagonally from top of Right Door Upright to bottom of Left Door Upright.

If the diagonal measurements do not match, adjust the position of the Door Uprights and take both measurements again repeating this process until the measurements are the same.

The Door is Square when both diagonal measurements are the same.

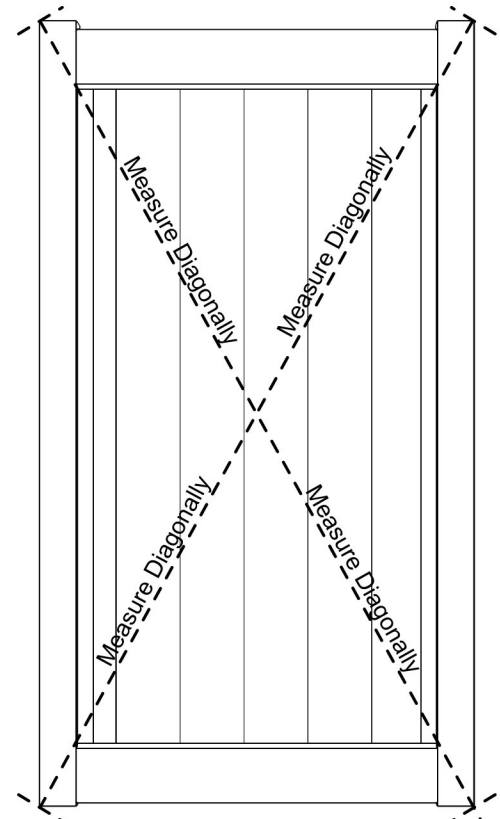

## 5. Door Assembly (Continued)

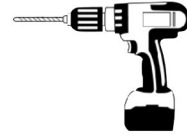

6. Drive screws through Door Uprights into Deco Rails as shown.

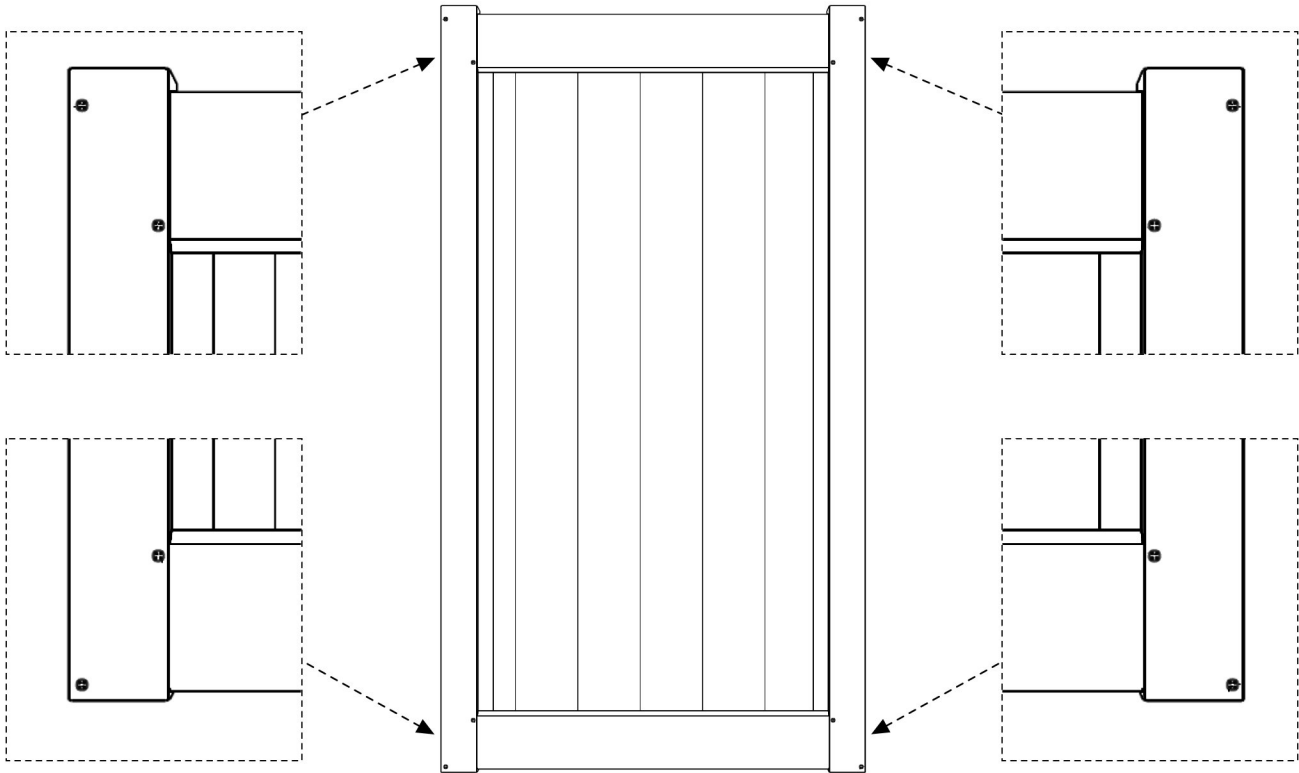

7. Place one Brace End Cap (G) on Brace (F).

**Note:** It is normal for the Brace End Caps to be tight fitting. If needed, use sandpaper or a file to shave the ends of the Brace slightly and tap with a mallet to help them go on the ends.

**Note:** Once Brace End Caps are on Brace, the ends of the Brace may show some deflection. This is normal.

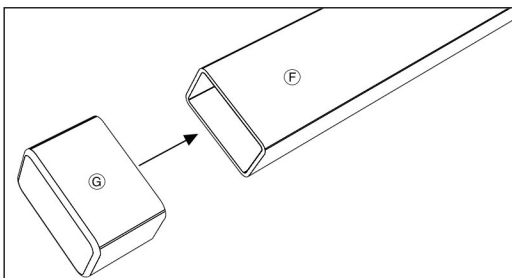

8. Lay Brace diagonally across Door with the Brace End Cap positioned in the bottom corner.

9. Mark the opposite end of the Brace where it will be cut.

Brace must be cut so that when the second end cap is on the Brace the Brace will lay flat on Door and both Brace End Caps will be positioned inside their respective corners.

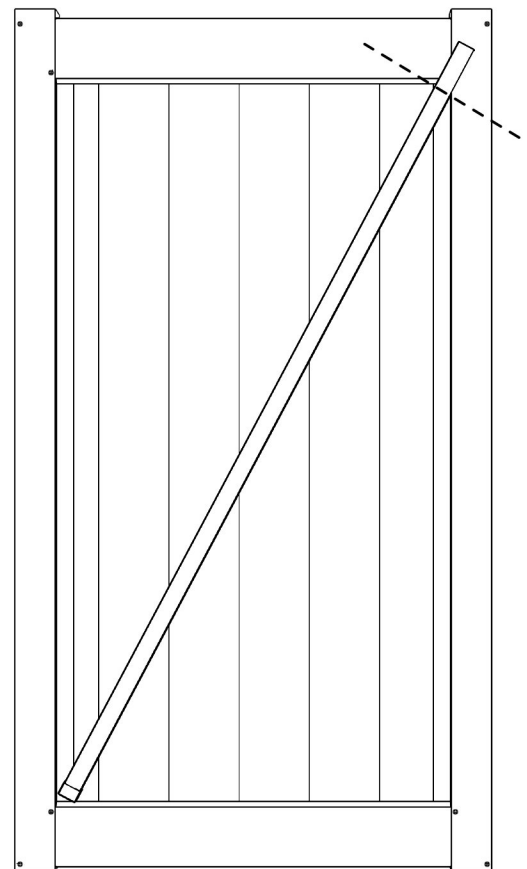

## 5. Door Assembly (Continued)

10. Cut Brace (F) and place second Brace End Cap (G) on end of Brace (F).

Lay Brace (F) diagonally across Door.

Secure Brace (F) to Door using one Screw per Brace End Cap (G) (centered) and each remaining Screw should be driven behind each seam where the Tongue and Groove Boards meet.

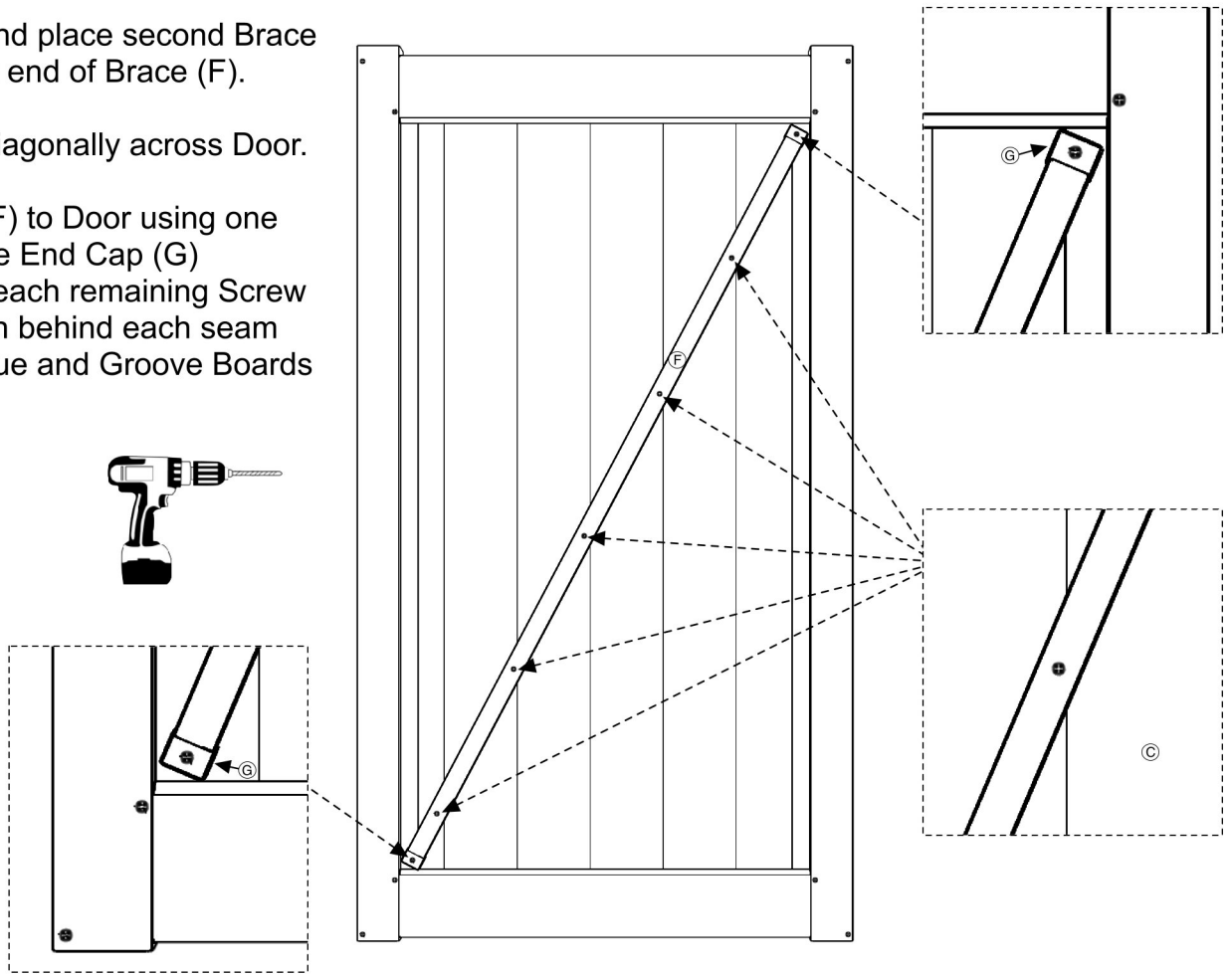

11. Apply adhesive to inside of Door Upright End Caps and place End Caps on top of Door Uprights.

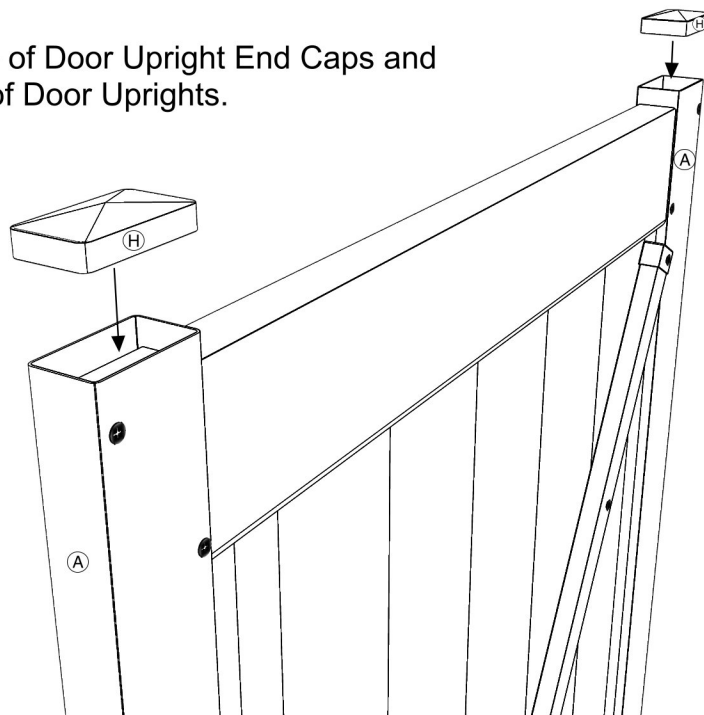

## 6. Door Hardware

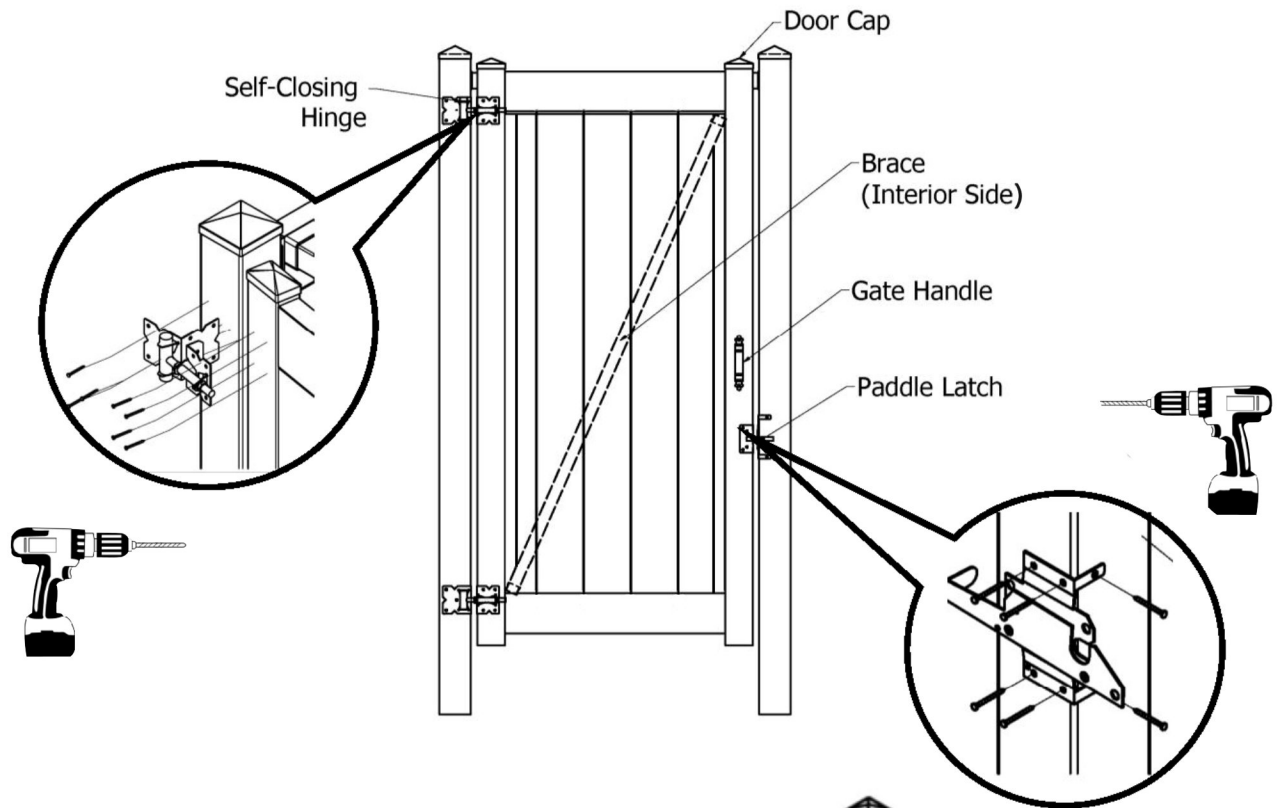

1. Attach door to post by first installing self-closing hinges as shown. Once hinges are mounted to post, lift and **screw** hinges to door. Hinges have adjustable nuts that are used to center the door in the opening.
2. Orientate door so that the brace is on the interior side of the enclosure and the top of the door is flush with wall panels.
3. Install gate handle and paddle latch at desired heights. Ensure that paddle latch components are aligned to allow the door to open and shut.

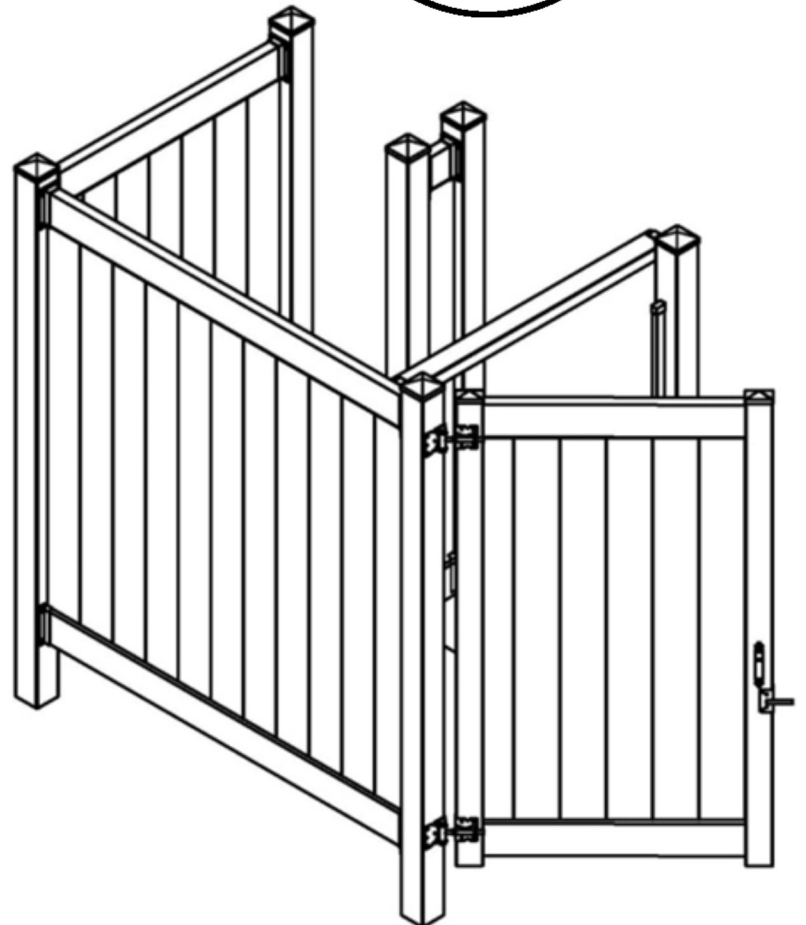

## 6. Privacy Strips (Hiney Hiders)

1. **Measure** and **cut** 7/8" x 1-1/2" vinyl strips to fit between door hardware. (paddle latch and hinges) Privacy strips cover gaps between door and posts but also act as door stops.
2. Cap privacy strips with 7/8" x 1-1/2" end caps. Apply **adhesive** for a stronger bond.
3. Mount privacy strips on posts behind door with **screws** provided. Strips should be installed with 7/8" side screwed to post.

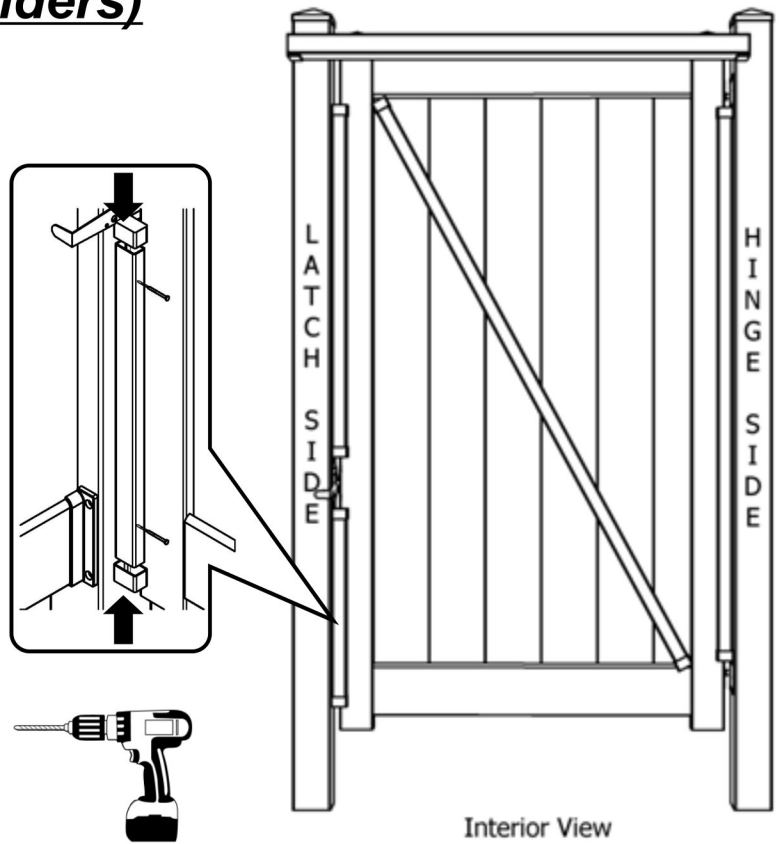

---

## 7. Louvered Roof

1. Assemble Louvered Roof components as shown. (Louvers, Roof Transoms, Caps)
2. Apply adhesive to roof caps for a stronger bond.

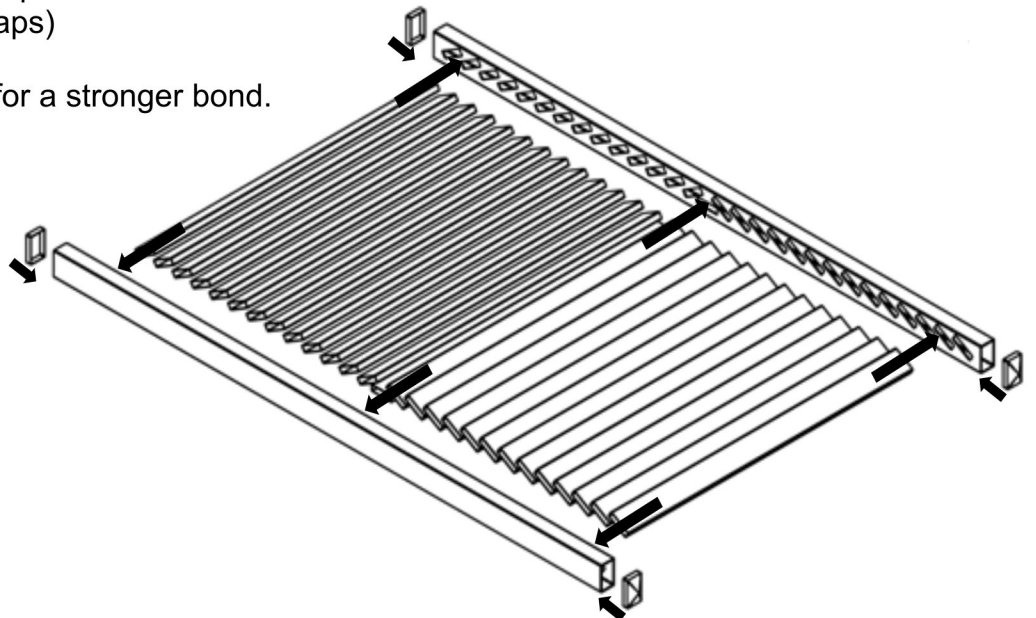

## 7. Louvered Roof (Continued)

3. Place Louvered Roof on Enclosure so that roof transoms rest on top deco rails and run parallel to door. Center roof so that over hangs are roughly equal.
4. Mount roof to top Deco Rail and Rail Transom with **screws** provided.

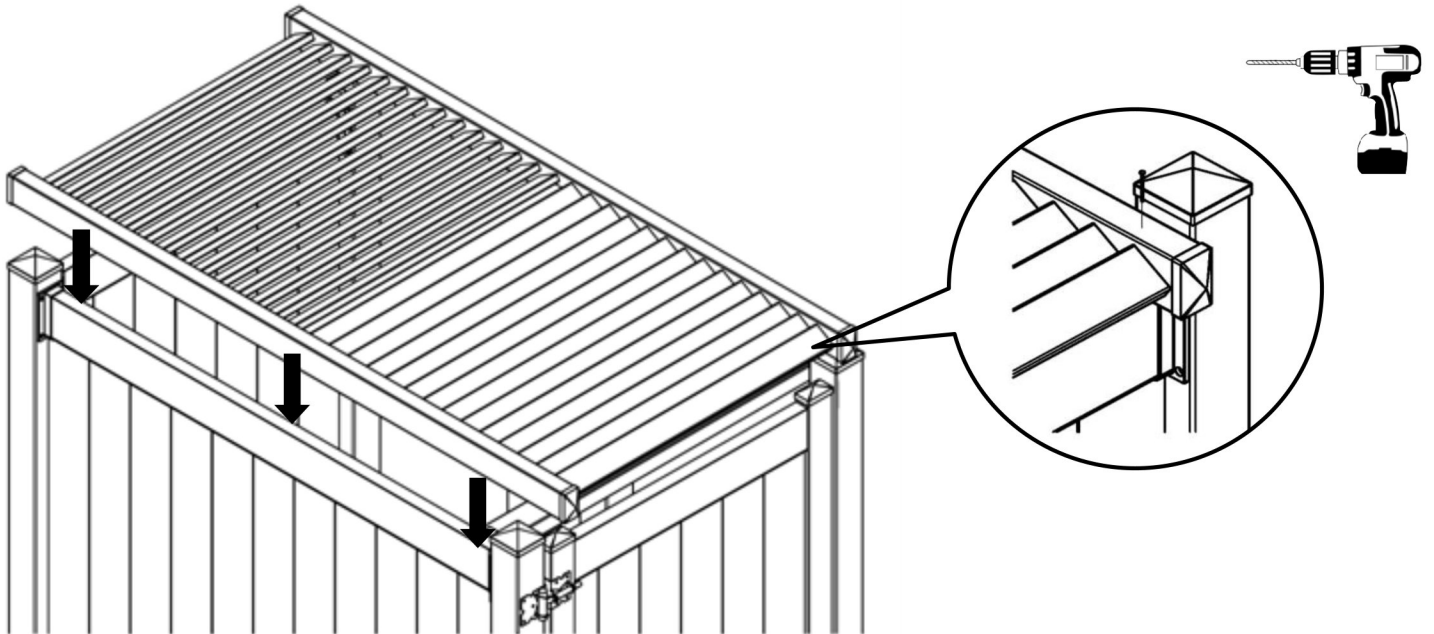

***Thank you for purchasing your  
Liquid Sunshine Shower  
Enclosure, Now Enjoy!***

*Still need help?*

**1-844-743-5140**

*Installation Support Hotline*

*WWW.OUTSIDESHOWER.COM*

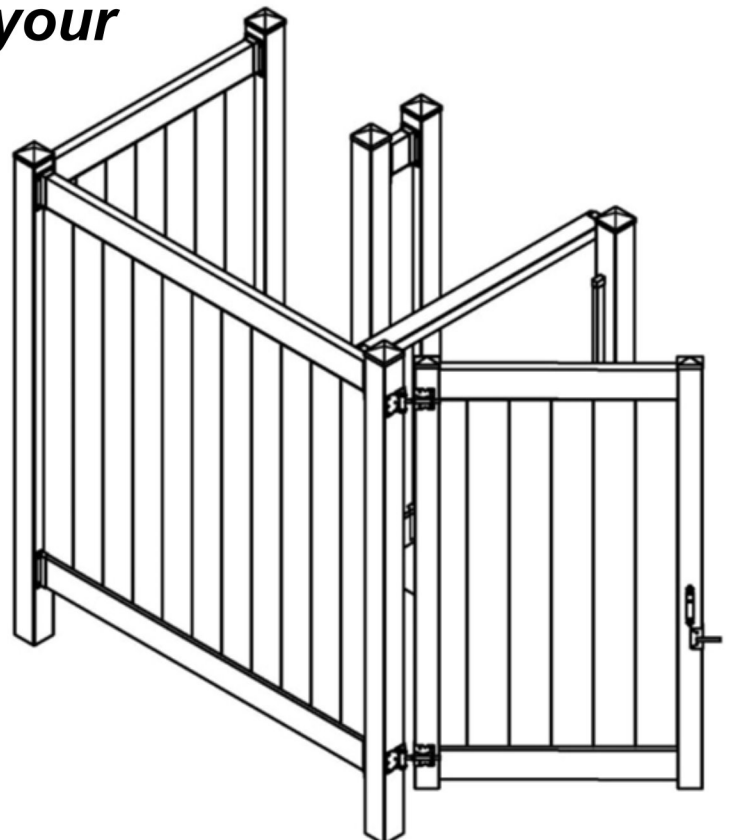

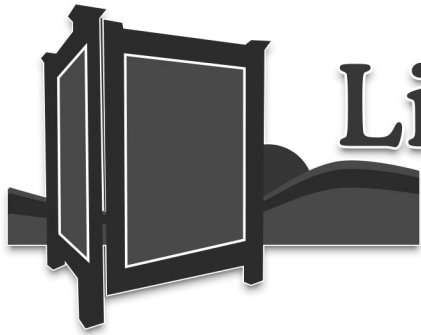

**Liquid Sunshine<sup>®</sup>**  
**OUTDOOR PRODUCTS**

---

Do Not Contact The Store About  
Missing Parts Or Installation Support.

---

**For Replacement Parts or Assistance:**  
**CALL 1-844-743-5140**

*View Installation Videos At:*  
**[WWW.OUTSIDESHOWER.COM](http://WWW.OUTSIDESHOWER.COM)**